

BLASTING EQUIPMENT
SPECIALISTS



PRODUCT CATALOGUE



2023

version 6.1



Gritco Equipment BV
Florijnstraat 93
2988 CL Ridderkerk
The Netherlands
+31 (0)180 412 855
info@gritco.com



Thirty years of designing, developing and manufacturing high quality blasting equipment has taught Gritco the importance of professional surface treatment for many manufacturing processes. Working with Gritco equipment you will profit a great deal from all our knowledge and experience.

Know how, 30 years of experience and Dutch quality

Gritco was founded in 1990 by Wim van der Made, already active in the blasting industry since 1968. Meanwhile the general management has been taken over by the 2nd generation van der Made's in the person of sun Sander. This family succession is one of the reasons Gritco customers can continue to count upon a steady company course dedicated to developing high quality, tailor made and economically sound blasting solutions.

Worldwide dealer network

During all these years Gritco has realized a solid network of dedicated dealers. Through this network Gritco's innovative blasting solutions find their way to a variety of both national and international customers who appreciate tailor made, high quality blasting solutions at competitive prices.

Gritco's product plus points

- No standard one-size-fits-all solutions but a wide range of specially developed blasting equipment for numerous different branches.
- Extended service life thanks to top quality, heavy duty, highly durable parts.
- Safety first design, development and manufacturing. According to (or proceeding) the latest regulations and legislation such as the European Directive PED 2014/68/EU.
- Full range of additional, high quality equipment and accessories.

Gritco service plus points

- Dedicated development of specific, innovative one-on-one blasting solutions.
- Thorough, practical know-how of all integrated blast chain processes, also of the subsequent painting and metalizing for instance.
- Quick response times in case of urgent delivery needs or product customization.

Blastpot type BM-EXC	3
Blastpot type BM-ECO	4
MicroStrip machines MM-A	5
Bulk machines	6
BM/MM Continuous	7
SubSea blasting systems	8
MiniPro-Basic	9
Dust free vacuum blast units (DFU)	10
MiniPro vacuum blaster	11
Custom built	12
Blast pot options	13
Blast pot options (wet blasting)	18
Pneumatic controls	19
Electro/pneumatic controls	20
Hose packages	21
Hose package options	24
Hose extensions	25
Nozzles	26
Internal pipe blasting equipment	30
After coolers	32
After cooler filter sets and frames	34
Blasting helmets	35
Blasting helmet extras	37
Airline filtration	38
Climate control	39
Gas monitor and PAPR	40
Blasting overall, suits & gloves	41
Mobile filter units	42
Blasting cabinets	43
Wet/vapour blast cabinets	45
Soda blasting cabinets	46
ARMEX® soda blasting media	47
Gritco Experience Center	48

**Contractors
Choice**

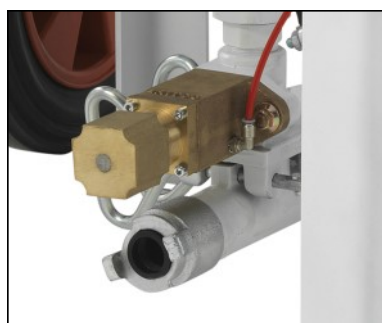

VERSITALE AND ECONOMIC CONTRACTOR'S CHOICE

As the abrasive metering valve only opens when blasting starts, the Excellent series waste no abrasives – as conventional blast pots do – with a costly, slow starting shot. Abrasive consumption is further more reduced by the precise abrasive metering possibilities

POWERFUL BENEFITS

- No slow abrasive starting shot
- Reduced dust by wet/vapour blasting possibilities
- Air (and water) cleaning/blowing off also possible
- Easy adjustable abrasive amount settings

BETTER BLASTING VALUE

- Wide choice in tannage varying from 18, 40, 60, 100 and 200 litre
- Accurate metering valve for less use of abrasives and dust production
- Meets most blasting needs because of extensive options
- No pressure drop because of large pipework
- (Spare) parts can be easily removed for quick maintenance

ENVIRONMENTALLY FRIENDLY

- Less compressed air consumption means less compressor energy and CO2
- Reduced waste and environmental pollution (dust) because of precise abrasive metering
- Less energy needed to attain the required blasting pressure

QUALITY INCLUDES

- Wear resistant metering valve handles all abrasives (also steel grits, fine aluminum oxide, etc.)
- Separate main air valve makes for little wear and maintenance
- No risk of abrasives entering the 'air section' because of separate decompression valve
- Wear disc in decompression valve for extended maintenance intervals
- System pressure gauge clearly indicates the compressor's pressure
- Spray painted, galvanized and non-ferrous fittings
- Completely safe according to European Directive 2014/68/EU



*Looking for an efficient blast pot that fits a wide variety of (basic) blasting disciplines?
Our Excellent Series offer you a wide range of professional possibilities at a well balanced budget.*

BM-EXC series blastpots

Blastpot BM-18-EXC, 18 liters, 3/4" piping	20060018
Blastpot BM-40-EXC, 40 liters, 3/4" piping	20060033
Blastpot BM-60-EXC, 60 liters, 1 1/2" piping	20060040
Blastpot BM-100-EXC, 100 liters, 1 1/2" piping	20060080
Blastpot BM-200-EXC, 200 liters, 1 1/2" piping	20060200

Options (for more info see pages 14-21)

S	C	Sm	R	F	H	T	V	VB	M
A	3m	3s	2	U	L	I	O	G	W2
Pc	E	167	ABE	Q	D	Y			



Most Efficient



Need a lot of start/stop/start intervals (i.e. blasting pipe joints or spot repair)? Then Gritco's ECO Blast Pots are your most efficient choice. For one because of their unique 'pressure hold system'.



FULL SPEED WHEN YOU NEED IT

After filling, the vessel gets pressurized first so the abrasive is 'on full speed' the moment you start blasting. So there's no time-, abrasive- or compressed air loss. Also excessive wear (i.e. of the decompression valve) is avoided. When fitted with 'Independently controlled multiple abrasive outlets' the ECO series are well suited for use in/as (semi) automatic systems.

POWERFUL BENEFITS

- Immediate start response for precise blasting and more production
- No slow abrasive starting shot
- Reduced dust by wet/vapour blasting possibilities
- Air (and water) cleaning/blowing off also possible

BETTER BLASTING VALUE

- Accurate metering valve for less use of abrasives and dust production
- Wide choice in tankage varying from 18, 40, 60, 100 and 200 liter (Spare) parts can be easily removed for quick maintenance
- Can meet any blasting need because of extensive options
- No pressure drop because of large pipework

ENVIRONMENTALLY FRIENDLY

- Less compressed air consumption means less compressor energy and CO2
- Reduced waste and environmental pollution (dust) because of precise abrasive metering
- Less energy needed to attain the required blasting pressure

QUALITY INCLUDES

- Wear resistant metering valve handles all abrasives (also steel grits, fine aluminum oxide, etc.)
- Separate main air valve makes for little wear and maintenance
- No risk of abrasives entering the 'air section' because of separate decompression valve
- System pressure gauge clearly indicates the compressor's pressure
- Wear disc in decompression valve for extended maintenance intervals
- Spray painted, galvanized and non-ferrous fittings
- Completely safe according to European Directive 2014/68/EU



BM-ECO series blastpots

Blastpot BM-18-ECO, 18 liters, 3/4" piping	20080018
Blastpot BM-40-ECO, 40 liters, 3/4" piping	20080033
Blastpot BM-60-ECO, 60 liters, 1 1/2" piping	20080040
Blastpot BM-100-ECO, 100 liters, 1 1/2" piping	20080080
Blastpot BM-200-ECO, 200 liters, 1 1/2" piping	20080200

Options (for more info see pages 14-21)

S	C	Sm	R	F	H	T	V	VB	M
A	3m	3s	2	U	L	I	O	G	W2
Pc	E	167	ABE	Q	D	Y			

Most Precise



IMMEDIATE START/STOP RESPONSE AND PRECISE ABRASIVE DOSSAGE

The Microstrip blast pot decompresses only when it needs refilling. Because of this the abrasive is on 'full speed' the moment you start blasting. By in- or decreasing the pressure difference of the tank- and blast pressure more or less abrasive will be forced through the fixed caliber. This high tech feature enables very accurate blasting with minimal usage of (even the finest) abrasives.

POWERFUL BENEFITS

- Immediate start/stop response for very accurate blasting
- No slow abrasive starting shot, no abrasive spill
- Less dust by wet/vapour blasting possibilities
- Air (and water) cleaning/blowing off also possible
- Easy setting and clear display of blasting and differential pressure

BETTER BLASTING VALUE

- Possible blockage is instantly fixed by the unique clean-out-port
- Equally good settings for every (new) project because of unique dosing method
- Wide choice in tankage varying from 18, 40, 60 to 100 liters
- (Spare) parts can be removed easily for quick maintenance
- Best possible solution for very precise & cost effective soda blasting

ENVIRONMENTALLY FRIENDLY

- Decompressing for filling only means less usage of compressed air resulting in less energy consumption and CO2 emission
- Reduced abrasive usage, waste and environmental pollution (dust) because of precise abrasive metering

QUALITY INCLUDES

- Wear resistant metering valve handles all abrasives
- Pneumatic ball vibrator ensures a constant flow of the finest abrasives
- Spray painted, galvanized and non-ferrous fittings
- Completely safe according to European Directive 2014/68/EU



Precisely controlled, constant dosage of even the finest abrasives at all blast pressures make Gritco's Microstrip the best possible solution for restoration projects and soda blasting.

MM-A series MicroStrip machines

MicroStrip machine MM18-A, 18 liters, 3/4" piping	23250010
MicroStrip machine MM40-A, 40 liters, 3/4" piping	23250015
MicroStrip machine MM60-A, 60 liters, 1 1/2" piping	23250001
MicroStrip machine MM100-A, 100 liters, 1 1/2" ppg	23250006

Standard



Options (for more info see pages 14-21)

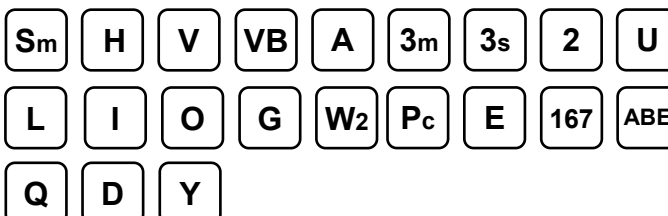



Because of their large tankage and multiple abrasive outlet possibilities, Gritco's Bulk Series Blast Pots are your best choice when extra capacity is needed for High-Capacity Blasting Jobs.



Model shown with 'big-bag frame' c/w lifting frame for the simplified, quick and repetitive filling of the tank. Actual configuration of the machine and frame can be customized depending on setup, on-site situation, method of filling, etc.

VERSATILE, HIGH PRODUCTION BLASTING EQUIPMENT

No loss of time, abrasives and/or compressed air is achieved because the vessel gets pressurized first after filling so the abrasive is 'on full speed' the moment the blasting procedure starts. Simplified fast and repetitive abrasive filling by means of the hopper on top of the large 500 litre tank. The capacity can be improved even further placing the pot under a silo or fit the machine with a framework containing abrasive big-bags. When fitted with 'Independently controlled multiple abrasive outlets' the Bulk Series is well suited for use with two or three blaster or in/as (semi) automatic systems.

POWERFUL BENEFITS

- Easy filling with the filling hopper and self closing bronze filling cone
- No slow abrasive starting shot
- Fast decompression by the two decompression valves with double silencers
- Reduced dust by wet/vapour blasting possibilities

BETTER BLASTING VALUE

- Accurate metering valve for less use of abrasives and dust production (Spare) parts can be easily removed for quick maintenance
- No pressure drop because of large pipework

ENVIRONMENTALLY FRIENDLY

- Reduced waste and environmental pollution (dust) because of precise abrasive metering
- Less energy needed to attain the required blasting pressure
- Less compressed air consumption means less compressor energy and CO₂

QUALITY INCLUDES

- Wear resistant metering valve handles all abrasives (also steel grits, fine aluminum oxide, etc.)
- Wear discs in decompression valves for extended maintenance intervals
- Completely safe according to European Directive 2014/68/EU



Bulk series blastpots

ED-500-ECO-S/, single outlet	2058S1500
ED-500-ECO-S/2, double outlet	2058S2500
ED-500-ECO-S/3, triple outlet	2058S3500
Surcharge for full machine frame	2058S50FF
'Big-bag frame' complete with lifting frame	2058S50BB

Standard



Options (for more info see pages 14-21)

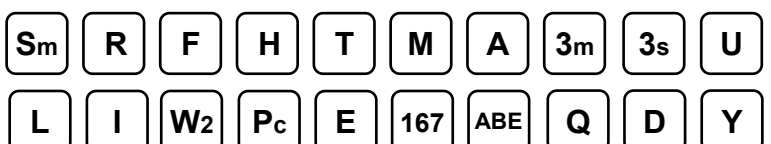



NON-STOP, EVEN FLOW OF ABRASIVES, NO PRESSURE DROPS

One of the advantages of robotized blasting is an even, constant workflow. With common (double chamber) blast pots however the pressure instability is a well-known problem. Just as the construction's height and poor accessibility of critical parts. Gritco's Continuous Series tackles these problems with two horizontally placed Gritco blasting vessels with interconnected abrasive metering valves delivering a continuous flow of abrasives. This is how it works:

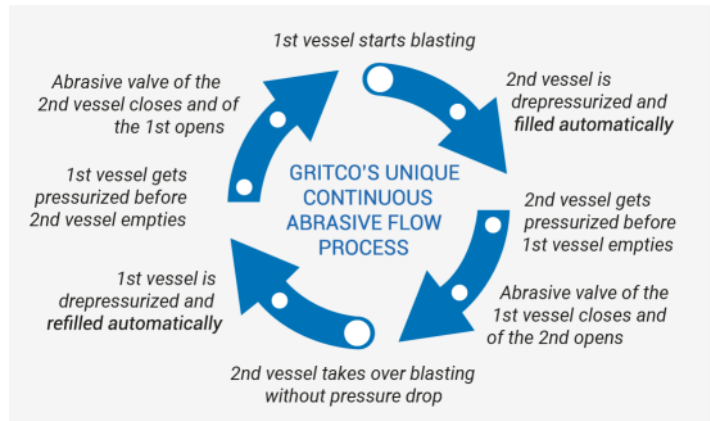

POWERFUL BENEFITS

Continuous blasting with optimal results, also during 'vessel change-over'

Meets with large air volume demands required for the large nozzles and high blasting pressure commonly used in robot blasting.
Independently controlled, multiple abrasive outlet possibilities

QUALITY INCLUDES

Wear resistant metering valve handles all abrasives (also steel grits, fine aluminum oxide, etc.)

Designed to endure extreme robotic blasting conditions such as long duration, compressed air pressure & volume and abrasive quantities
Spare parts are easily accessible and removed for quick and trouble free maintenance.

Completely safe according to European Directive 2014/68/EU



Optimize robotized blasting with Gritco's unique Continuous Series. Especially designed, horizontally placed blasting vessels with interconnected abrasive metering valves deliver an even, ongoing supply of abrasives.

Please contact us for detailed information and possible executions of the Continuous series.

BlastMate Continuous

BM-200-CNTNS, 200 liter model	20090200
-------------------------------	----------

MicroStrip machine Continuous

MM200-CNTNS, 200 liter model	23205200
------------------------------	----------

Standard



Options (for more info see pages 14-21)

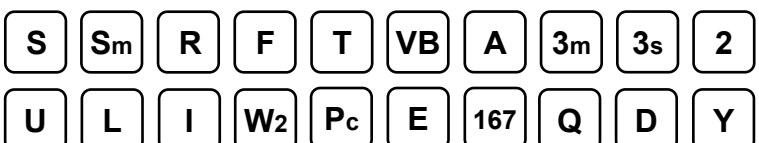



Blasting underwater structures with compressed air is a perfect way to remove dirt, paint and corrosion. With Gritco's specially developed SubSea Series the job can be done more safe and economical than ever before.



SAFE, SILENT SUBSEA BLASTING WITH EASY NOZZLE CONTROL UP TO 300 METERS

Compared to onshore blasting, subsea blasting requires much higher system pressures (because of ambient underwater pressures). In HP-water systems these high pressures create safety issues and heavy working conditions for the diver. With an extremely low nozzle pressure of just 2 to 6 bar, Gritco's SubSea Series provide much safer and comfortable working conditions. "Blasting underwater structures with compressed air is a perfect way to remove dirt, paint and corrosion. With Gritco's specially developed SubSea Series the job can be done more safe and economical than ever before."

POWERFUL BENEFITS

- Ultimate diver safety caused by low blasting pressures and uninterrupted, 2-way diver-to-crew communication (because of silent underwater operation)
- No retro jets because of low, minimal pressures (unlike High Pressure Water systems)
- Light and easy, one hand nozzle handling
- Production output doubles that of HP-water systems
- Design and production are based upon decades of knowledge and experience

BETTER BLASTING VALUE

- Different surface finishes can be obtained with simple pressure control varying from marine growth removal to bare metal finish
- Perfectly matt, non-reflective finish for remote observation and subsea inspection
- Exceeds SA2.5 standard (e.g. for repainting)
- Wide range of models and full back up possibility
- Blasting depth possibilities range from 50 (standard series) to 300 meters (special series)

BETTER BLASTING ECONOMICS

- Silent underwater operation allows Constant 2-way Diver-to-Crew communication
- Doubles the blasting output of HP-water systems

QUALITY INCLUDES

- Double safety and emergency stop features
- Time tracking for on-time replacement of critical (wear) parts
- Completely safe according to European Directive 2014/68/EU



Please contact us for detailed information and possible executions of the SubSea blasting systems, ranging from 50 (standard series) to 300 meters (special series) of blasting depth.

Subsea standard (up to 50 meters depth)

Subsea Blasting System BM-200-ECO	20088200
-----------------------------------	----------

Subsea special (up to 200 or 300 meters depth)

Subsea Blasting System (25 bar, double pot)	20SUBSEAFR
Subsea Blasting System (35 bar, double pot)	20SUBSEA35

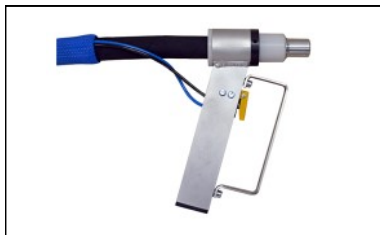

Choice of hose package with pistol grip or heavy duty G2 deadman



Based upon Gritco's high quality standards, extensive experience and know-how the MiniPro Blast Pot Series is designed as a compact, economical but professional alternative for less than full time blasting use with ultimate results.

VERSATILE AND ECONOMIC APPLICATIONS

Despite its compact dimensions, the MiniPro-Basic is a mature blasting machine offering many of Gritco's high-quality advantages. The machine is often used for "basic" blasting work like rust and paint removal. Due to the accurate pressure setting and abrasive metering, the MiniPro-Basic can also be deployed for more delicate work.

POWERFUL BENEFITS

- Easy adjustable abrasive amount settings
- Reduced dust by wet/vapour blasting possibilities
- Easy adjustable pressure settings

BETTER BLASTING VALUE

- Accurate metering valve for less use of abrasives
- (Spare) parts can be easily removed for quick maintenance

ENVIRONMENTALLY FRIENDLY

- Reduced waste and environmental pollution (dust) because of precise abrasive metering

QUALITY INCLUDES

- Wear resistant metering valve handles all abrasives
- No risk of abrasives entering the 'air section' because of separate decompression valve
- Completely safe according to European Directive 2014/68/EU



Beware: the MiniPro is a full blown professional machine! Despite its compact size this blast pot series has been developed and built for high quality, professional use. The MiniPro's professional character has resulted in a competitive yet corresponding price level.

MiniPro-Basic

MiniPro-Basic	2001BT18
10 m. hose package with G2 deadman control	18000410
10 m. hose package with pistol grip	180000MP
3,2 mm tungsten carbide nozzle	15000002
4,8 mm tungsten carbide nozzle	15000003

Standard



Options (for more info see pages 14-21)





CLEAN BLASTING AND ECONOMIC RECYCLING OF ABRASIVES

As the actual blasting is sealed off by a brush head, dust and abrasives are immediately vacuumed by a powerful suction unit. The separator and silo fully recycle the collected, used abrasives. The automatically contained dust can be simply discharged. Gritco's vacuum blasting is a safe blasting solution for confined or critical areas (with a lower working speed compared to 'open' blasting).

POWERFUL BENEFITS

- 100% dust free operation because of fully automated blasting & vacuum start/stop sequence
- Clean, abrasive free object surface after blasting
- No time-loss through automatic filter cleaning and dust discharge
- Easy disposal of collected dust in plastic bags
- Unit can be relocated and/or transported easily
- Wide range of brushes to fit all (flat, cornered, radiused) surfaces

BETTER BLASTING VALUE

- Long(er) uninterrupted blasting sessions because of 40, 60 or 100 litre blast pots
- Suited for all abrasives, also 'heavy ones' like steel shot or chilled iron grit
- Blasting patterns 50 or 75 millimetres

ENVIRONMENTALLY FRIENDLY

No dust and contamination which are collected in plastic bags for safe disposal

QUALITY INCLUDES

- Renowned Nederman vacuum equipment for top results at low energy use
- Wear resistant metering valve handles all abrasives (also steel grits, fine aluminium oxide, etc.)
- Separate main air valve makes for almost wear- and maintenance free use
- Spray painted, galvanized and non-ferrous fittings
- Complete safety according to European Directive 2014/68/EU



Vacuum, or dust free blasting is ideal for spot repairs, welding seams and/or situ blasting in working environments where dust- and abrasive pollution is to be avoided.

DFU vacuum blast units

DFU-E with electric vacuum	08DFU403R
DFU-PN with pneumatic vacuum	08DFU4042

Extras

Hose extension 10 meter (pneumatic only)	08700015
Floor cart c/w large blast- and vacuum head	08700000N
Surcharge for NE52 pneum. vacuum (for 30 m hose)	08DFUSC52
Surcharge for NE64 pneum. vacuum (for 40 m hose)	08DFUSC64
Surcharge for NE74 pneum. vacuum (for 50 m hose)	08DFUSC74



Various brushes available for inner, outer corner and different radiuses.



CLEAN BLASTING AND ECONOMIC RECYCLING OF ABRASIVES

As the actual blasting is sealed off by a brush head, dust and abrasives are immediately vacuumed by a powerful suction unit. The separator and silo fully recycle the collected, used abrasives. The automatically contained dust can be simply discharged. Vacuum, or dust free blasting is ideal for spot repairs, welding seams and/or situ blasting in working environments where dust- and abrasive pollution is to be avoided. Gritco's vacuum blasting is a safe blasting solution for confined or critical areas (with a lower working speed compared to 'open' blasting).

POWERFUL BENEFITS

- Dust free operation because of automatic blasting & vacuum sequence
- Clean, abrasive free object surface after blasting
- Unit can be relocated and/or transported easily
- Wide range of brushes to fit all (flat, cornered, radiused) surfaces

BETTER BLASTING VALUE

- Suited for abrasives like glass beads, garnet and aluminium oxide
- Blasting pattern of 30 millimetres
- Small portable design for use in contained spaces (ships, tanks, etc.)

ENVIRONMENTALLY FRIENDLY

- No dust and contamination which are collected in a drum for safe disposal

BETTER BLASTING ECONOMICS

- Saving on abrasives because of closed circuit recycling

QUALITY INCLUDES

- Renowned Nederman vacuum equipment for top results at low energy use
- Wear resistant metering valve which can easily be removed for quick maintenance
- Complete safety according to European Directive 2014/68/EU



Based upon Gritco's high quality standards, extensive experience and know how the MiniPro Vacuum Blasting is designed as a compact, economical but professional alternative for less than full time blasting use with ultimate results.

MiniPro vacuum blast units

MiniPro vacuum blaster with electric vacuum	0808MPEL
MiniPro vacuum blaster with pneumatic vacuum	0808MPPN

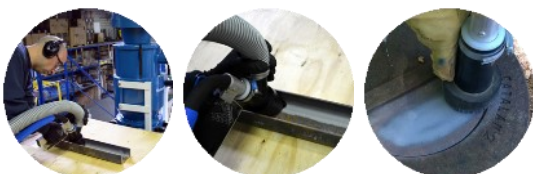

Various brushes available for inner, outer corner and different radiuses.

DESIGNED AND MANUFACTURED TO FIT THE JOB

Looking for something (a little) different than our standard models and extensive list of options? We can design and build machines to fit your needs!

This can be a modification of a standard machine, a completely new machine but also a combination of machines to make one ready-to-go unit.

A SELECTION OF THE POSSIBILITIES

- Special colours
- Transport skids
- Combi units of blast pot and aftercooler
- Skid units including compressor
- Integrated water tanks
- Trailer mount systems
- Different shape or content of blast pots
- Blast room and abrasive recycling solutions
- Different types of valves
- Customized control boxes
- And much more...

QUALITY

Be assured that also the custom made machines are built from the best high quality components and are complete safety according to European Directive 2014/68/EU.



Contact our design team to discuss your case and to make an inventory of all the possibilities.



S**Sieve**

The strong steel sieve fits the pot perfectly. With its mesh of 7 mm too big particles cannot enter the pot.

Sieve for 18 liter models	20030018
Sieve for 40 liter models	20030033
Sieve for 60 liter models	20030040
Sieve for 100 liter models	20030080
Sieve for 200 liter model	20030130

C**Cover**

The strong steel cover avoids foreign object entering the pot. The optional sieve is necessary to install the cover.

Cover for 18 liter models	20040018
Cover for 40 liter models	20040033
Cover for 60 liter models	20040040
Cover for 100 liter models	20040080
Cover for 200 liter models	20040130

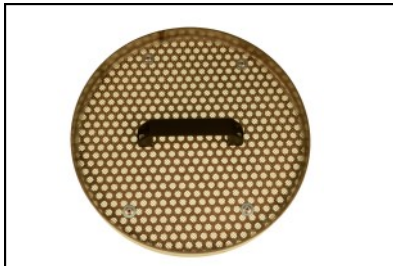
Sm**Micro sieve**

This stainless steel sieve is especially for MicroStrip machines. The mesh of 2 mm avoids blockages of the small orifices of the metering sleeve. Should be combined with the sieve, option 'S'

Micro sieve for 18 liter models	20035018
Micro sieve for MiniPro models	200350MP
Micro sieve for 40 liter models	20035040
Micro sieve for 60 liter models	20035060
Micro sieve for 100 liter models	20035100

R**Pressure reducer**

With the precise pressure reducer and glycerin filled gauge the wanted blast pressure can easily be set.

Pressure reducer 3/4" for 18 and 40 liter model	19030002
Pressure reducer 1 1/2" for all other models	19030005

F**Compressed air filter**

The compressed air filter takes out the last bits of contamination and moisture ensuring fault free performance of the machine. The filter is executed with an automatic drain.

Compressed air filter 3/4" for 18 & 40 liter model	23000034
Compressed air filter 1 1/2" for all other models	23000112

H

**Helmet air filter**

The activated carbon filter removes odors of oil for fresh air to the operator's helmet or airhood. A pressure reducer is added for the correct settings of the airflow. This option should be combined with the compressed air filter option 'F' which functions as a pre-filter.

Helmet air filter for all models	22HELM01
----------------------------------	----------

T

**Pneumatic ball vibrator**

For a constant and regular flow of fine, angular and/or hygroscopic abrasives this option can be installed. It keeps the abrasive in motion to ensure a perfect flow and metering.

Pneumatic ball vibrator for 18 & 40 liter models	20000006
Pneumatic ball vibrator for all other models	23200700

V

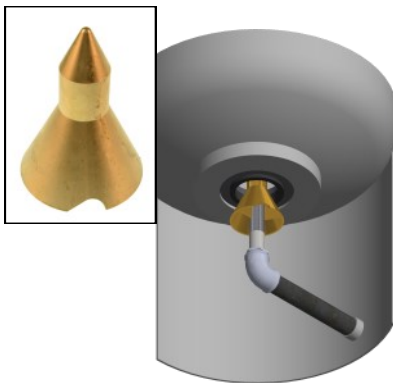
**Filling cone assembly**

When placing a blastpot under a silo, problems can occur with the closure of the standard rubber pop-up. Especially with lower pressures the pop-up sometimes doesn't close completely against the amount of abrasive laying on top.

The bronze filling cone will cut better through the abrasive because of its shape. The cover above it will make sure there's always some free space to push the abrasive away to.

Filling cone assembly instead of rubber pop-up	21101410
--	----------

VB

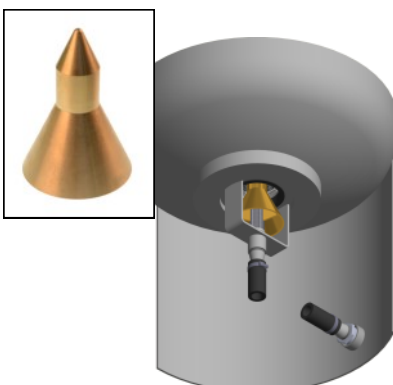
**Filling cone assembly "Heavy Duty"**

For applications with heavy abrasives (e.g. steel grit) and/or a lot of filling cycles, the filling cone can be placed on a special "bridge" construction. This avoids any possible deformation of the blast pot's standard internal piping and ensures a 100% alignment of the cone. Another advantage is that the filling cone and closing ring can now easily be changed through a top flange of the blast pot instead of the inspection hatch.

This option is only available for 200 liter blast pots.

Filling cone assembly "Heavy Duty" (200 l only)	21101410VB
---	------------

A

**Silo connection**

To ensure a dust free connection between the abrasive silo and the blast pot, a special cover can be mounted on the machine's sieve. Two clamps ensure a dust tight fit and the exhaust of the cover lets out the air during (de)compression of the blast pot.

Silo connection	20040500
-----------------	----------

M

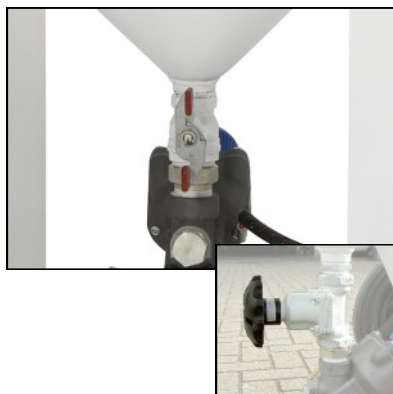
**Maintenance valve**

When the blastpot will be placed under a silo, it is advisable to order this option. With this maintenance valve the blastpot can be closed so the pot won't run empty when the abrasive metering valve is being removed for maintenance.

The standard version is a ball valve type. The Saunders diaphragm valve is advised for more frequent use and/or better wear resistance.

Maintenance valve standard version	2200200M
Saunders membrane valve version	19200004

3m

**3rd signal on machine (3m)**

With this function on the machine, the abrasive metering valve can be shut off so no abrasive will come out of the nozzle. Objects can then be cleaned with air (and water) only.

3 rd signal on machine for all models	16202040
--	----------

3s

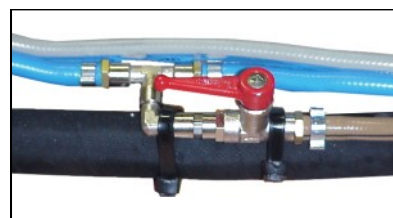
**3rd signal on hose package (3s)**

With this valve at end of the machine's hose package, the blaster can easily close the abrasive metering valve so objects can be cleaned with air (and water) only.

3 rd signal on hose package (to be ordered together with a hose package)	18900000
---	----------

2

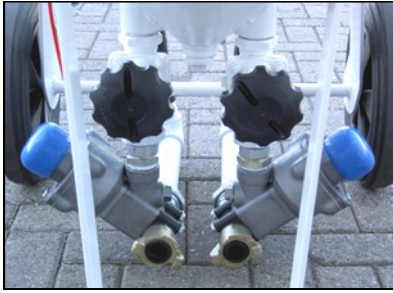

Multiple outlets

All series blast pots can be executed with multiple abrasive outlets (models 100 and larger). *Contact us for more information.*

U



Timer unit

The two digital hour counters are powered by a small long life time battery. The total working time of the machine is monitored together with the job time. The job time can be reset only with a key . The start signal can either be connected to the main air valve or the abrasive metering valve depending on the purposes. Ideal for job cost calculation or hire applications!

Double hour counter with key reset	23906070
------------------------------------	----------

L

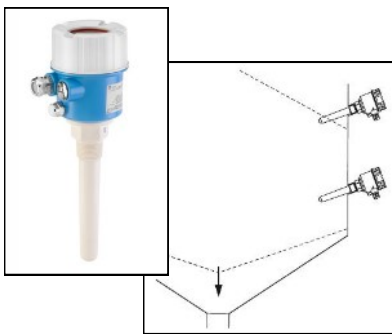

Level indicator

This option can be installed to measure the level of abrasive. When integrated with a switchboard it can warn e.g. when the blast pot is about to run empty or when it's full to start the blasting process. The level indicator functions with DC 20...55V and AC 20...253V. Depending on application and model size, the level indicator can be placed at various positions of the vessel.

1 piece level indicator for all models	22LEVEL1
2 pieces level indicator for all models	22LEVEL2

I

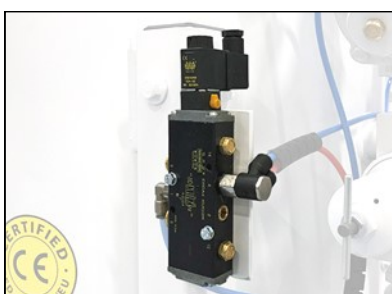

Inhibitor switch

This electro pneumatic inhibitor switch can be integrated with a switchboard when e.g. the blasting process needs to be stopped when the door(s) from the blast room are accidentally opened. It can be delivered in a 24V DC or 240V AC execution.

Inhibitor switch for all models 24V DC	50032024
Inhibitor switch for all models 240V AC	50032240

O

**Hose bracket**

This bracket on the front of a 40, 60, 100 or 200 liter machine can hold a hose package of maximum 20 meters.

Storing and moving the machine becomes very easy!

The hose package's couplings stay connected, so startup of the can be done quickly.

Hose bracket for 40, 60, 100 and 200 l models	220HB000
---	----------

G

**Gauge panel**

To give extra protection to the machine's pressure gauges, we can install a panel into which the gauges will be integrated.

This option is advisable when the machine is frequently moved or for rental purposes.

Gauge panel for all models	MANOPANE
----------------------------	----------

Q

D

**Galvanizing (Q) / Duplex (D)**

Most of our blast pots can be galvanized for the best protection against harsh environment conditions e.g. offshore. It ensures a very long machine life and prevents corrosion problems during periodic inspections of the pressure vessel.

A duplex treatment is also possible. After galvanizing the blast pot is then double powder coated in a RAL color of your choice.

Galvanizing 18, 40, 60 liter + sieve and cover	22GLV018
Galvanizing 100 liter models + sieve and cover	22GLV100
Galvanizing 200 liter models + sieve and cover	22GLV200
Duplex for 18, 40, 60 liter + sieve and cover	22DPX018
Duplex for 100 liter models + sieve and cover	22DPX100
Duplex for 200 liter models + sieve and cover	22DPX200

Y

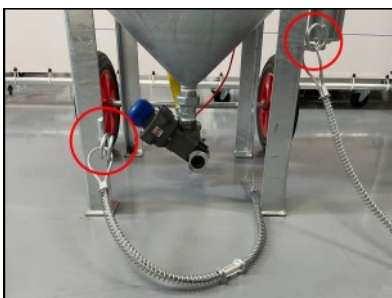
**Whip check coils**

Two coils can be mounted to the machine to safely connect whip checks. One for the compressed air supply hose and the other for the abrasive blast hose.

Delivery is complete with two whip checks.

Whip check coils c/w two whip checks	WHIPCOIL
--------------------------------------	----------



To limit the spread of dust during blasting, water can be added to the abrasive/air mixture using a wet blast attachment as shown on page 21-22.

For the supply and start/stop of the water one of the below options can be built on our machines.

W₂



Water connection

This option can be installed on the machine when wet blasting with the Water Jet Nozzle 'WJN' .

The water valve opens/closes the water supply when the deadman handle is pressed/released. This ensures that no water can run into the nozzle (and back to the machine!) when not blasting.

Also a water filter is installed to prevent blockages in the wet blast attachment.

Tap water with enough pressure to reach the nozzle is necessary to function.

Water connection for all models	23000300
---------------------------------	----------

P_c



Membrane pump unit, type C

This option can be installed on the machine when wet blasting with the 'WJN' nozzle or attachment 'KWB/Mini' and 'KWB/M'.

The pump's function is to bring the water to the wet blast attachment when there is no tap water available or when working at heights or with long hose lengths.

The pump unit also sucks water from e.g. a barrel or tank when the blast machine is used on various locations.

For use in combination with the KWB-Mini and KWB-M the pump's function is also to inject the water into the abrasive and air stream.

Therefore the water pressure needs to be higher than the air pressure. This type of mixing gives the best result in dust control with a minimum amount of water.

The pump unit is started/stopped by the signal from the deadman handle. The unit comes complete with pressure regulator, water filter and supply shut off valve

Max. air pressure	:	7 bar
Pump ratio	:	1:1
Max. suction height, dry	:	2.5 m
Max. suction height, filled	:	4.4 m

Membrane pump unit for all models	23000405
-----------------------------------	----------



For blasting pressures above 7 bar, the above pump unit (Pc) can be used in combination with the WJN nozzle. When one of the KWB attachments is preferred, a pump unit with a higher outlet pressure is required. Please contact us for more info and the different possibilities.

E



Emergency stop

This pneumatic emergency stop can be installed i.e. for automatic blasting jobs where the controller can stop the blasting process with just a press on the button.

Emergency stop for all models	21104000
-------------------------------	----------

167



Pneumatic timer control box PL167

This adjustable time delayed remote control box enables the emptying of the blast hose at every start and stop when working with long blast hose lengths and/or at heights.

The control unit is executed with two pneumatic timers which are adjustable with a maximum delay of 30 seconds.

The timers activate the main air valve and abrasive valve in the following order:

Start: By pressing the deadman handle the main air valve is opened immediately, while the abrasive metering valve comes into action after the set delayed time.

Stop: By releasing the deadman, the abrasive metering valve closes immediately, while the main air valve stays open for the set time.

Timer control box PL167	21100167
-------------------------	----------



G2 Deadman handle

All our hose packages are executed with the unique G2 deadman handle which has an increased response time of more than 30% over other models!

The safety button is larger for easier operation and can be configured for both right and left-handed operators. The greater length and width of the lever requires just 1/3 of the force to depress compared to other models.

G2 deadman handle	2263-002
-------------------	----------



Nozzle and holder not included

G2 Trigger deadman

The Trigger G2 deadman is especially suited for blasting applications using smaller nozzles (up to 9.5 mm) and provides exceptional ease and comfort while maintaining the dependability and safety of the G2 deadman.

The ergonomic trigger grip provides comfortable hand position while blasting and can be configured for use by both lefthanded and right-handed operators. All standard blast nozzles and nozzle holders can be used in combination with the G2 Trigger.

G2 Trigger deadman	2263-004
--------------------	----------

ABE



Electro-pneumatic control boxes ABE

This electro-pneumatic remote control box enables to work with an electric deadman control which is advised for hose lengths of 60 meters or longer. Advantage is the immediate start/stop of the blast machine when operating the deadman control.

The box requires a 24V DC or a 220-240V AC (1 phase, 50 Hz) connection. For 220-240V AC the box is executed with a transformer to convert to a safe 24V DC current.

The boxes can be delivered with a single function: blasting on/off or with a double function: blasting on/off and air only on/off. For the double function the below 3-wire control switch is needed (2145WT20)

Electro-pneumatic control boxes

E/P control box 24V DC, single function	211HMAB1L
E/P control box 220-240 AC, single function	211HMAB1T
E/P control box 24V DC, double function	211HMAB3L
E/P control box 220-240 AC, double function	211HMAB3T



Nozzle and holder not included

G2E Electric deadman handle

The G2E deadman handle has a large safety button for easy operation and can be configured for both right and left-handed operators. The greater length and width of the lever requires just 1/3 of the force to depress compared to other models.

Also available in the "Tigger" version which provides comfortable hand position while blasting with nozzles up to 9.5 mm.

Electric deadman handle

G2E Deadman control (electric)	2263-402
G2E Trigger deadman (electric)	2263-404



Deadman control switches

Preferred by contractors for maximum safety and reliability with optional ball & chain for ease of use. The all polyurethane construction is specifically designed for use in harsh conditions. The switches are easily field repairable with the separately available repair kits.

The switches are available as a 2-wire or 3-wire model and can be custom built with longer cables.

Deadman control switches

Control switch 2-wire (c/w ball and chain)	2145WT20
Control switch 3-wire (c/w ball and chain)	2145WT30



Cable and connectors

PUR cable 2 x 1,5 mm ² , yellow	50PUR002
PUR cable 3 x 1,5 mm ² , yellow	50PUR012
Plug 4 pole, pin (CA 3 LS)	50902000
Contra plug 4 pole (CA 3 LD)	50902010

Hose package 'dry'

The hose package is delivered complete with blast hose, twin hose, couplings, nozzle holder and deadman handle type G2. A nozzle is not included.

The plastic (POM) nozzle holder has 3/4" BSP thread.



10 meters

Hose package 'dry', 1/2" hose, 3/4" BSP holder	18000410
Hose package 'dry', 3/4" hose, 3/4" BSP holder	18000510A

20 meters

Hose package 'dry', 1/2" hose, 3/4" BSP holder	18000420
Hose package 'dry', 3/4" hose, 3/4" BSP holder	18000520A

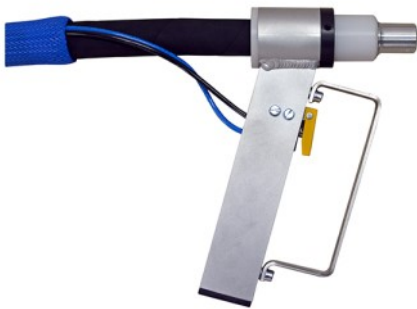

Hose package MiniPro 'dry'

The hose package is delivered complete with blast hose, twin hose, couplings, nozzle holder and deadman handle type G2. A nozzle is not included.

The nylon nozzle holder has 3/4" BSP thread.

10 meters only

Package MiniPro 'dry', 1/2" hose, c/w gun and 3/4" BSP holder	180000MP
---	----------

Hose package 'dry'

The hose package is delivered complete with blast hose, twin hose, couplings, nozzle holder and deadman handle type G2 . A nozzle is not included.

The nylon nozzle holder ensures a smooth connection of the nozzle and comes with 50 mm coarse thread.



10 meters

Hose package 'dry', 3/4" blast hose	18000510
Hose package 'dry', 1" blast hose	18000610
Hose package 'dry', 1 1/4" blast hose	18000710

20 meters

Hose package 'dry', 3/4" blast hose	18000520
Hose package 'dry', 1" blast hose	18000620
Hose package 'dry', 1 1/4" blast hose	18000720
Hose package 'dry', 1 1/2" blast hose	18000820



Functions with

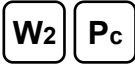

(more info on page 18)



Hose package 'wet' type WJN-Mini

This hose package can be used in combination with blastpot option 'W2' and 'Pc'. The hose package is delivered complete with blast hose, twin hose, water hose, couplings, nozzle holder, deadman handle type G2 and regulator valves for the water mixing. Also the WJN-Mini attachment is delivered which fit over of a 3.2 or 4.8 mm HYDB nozzle which is not included and should be ordered separately. Water and air/media is mixed inside the WJN-mini and tap water can be used because of its unique induction design. There's also a MiniPro version available with a pistol grip control.

10 meters

Hose package 'wet', WJN-Mini, 1/2" blast hose	18420410
Hose package 'wet', WJN-Mini, 3/4" blast hose	18420510A

20 meters

Hose package 'wet', WJN-Mini, 1/2" blast hose	18420420
Hose package 'wet', WJN-Mini, 3/4" blast hose	18420520A

MiniPro version (10 meters only)

Package MiniPro 'wet', WJN-Mini, 1/2" hose	184200MP
--	----------

Nozzles

Nozzle HYDB2, 3.2 mm Ø, l = 45 mm	15000002
Nozzle HYDB3, 4.8 mm Ø, l = 45 mm	15000003
Rubber washer	15500002



Functions with

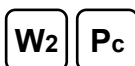

(more info on page 18)

Hose package 'wet' type WJN

This hose package can be used in combination with blastpot option 'W2' and 'Pc'. The hose package is delivered complete with blast hose, twin hose, water hose, couplings, nozzle holder, deadman handle type G2 and regulator valves for the water mixing. The actual mixing of the water is done by the Water Jet Nozzle (WJN) is not included and should be ordered separately (see page 28)

Water and air/media is mixed inside the WJN nozzle. Tap water can be used because of its unique induction design.

10 meters

Hose package 'wet', WJN, 3/4" blast hose	18450510
Hose package 'wet', WJN, 1" blast hose	18450610
Hose package 'wet', WJN, 1 1/4" blast hose	18450710

20 meters

Hose package 'wet', WJN, 3/4" blast hose	18450520
Hose package 'wet', WJN, 1" blast hose	18450620
Hose package 'wet', WJN, 1 1/4" blast hose	18450720



optional Swirl Ring



Functions with



(more info on page 18)

Hose package 'wet' type KWB/Mini

This hose package is executed the same way as the KWB/M except for the wet blast attachment.

The fitted KWB/Mini attachment is suitable for all nozzles with 3/4" BSP thread (not included) and has the same user advantages as the KWB/M. However due to its small size and low weight it's very suitable for 'low pressure' jobs like restoration and graffiti removal.

The optional Swirl Ring creates in combination with the short HYDB nozzles a wider/'softer' blast pattern than normal .

10 meters

Hose package 'wet', KWB/Mini, 1/2" blast hose	18500410
Hose package 'wet', KWB/Mini, 3/4" blast hose	18500510

20 meters

Hose package 'wet', KWB/Mini, 1/2" blast hose	18500420
Hose package 'wet', KWB/Mini, 3/4" blast hose	18500520

'KWB/Mini' wet blast attachment only

'KWB/Mini' c/w regulator valves	15070015
---------------------------------	----------

Optional Swirl Ring

Swirl Ring for KWB/Mini	15070050
-------------------------	----------

Hose package 'wet' type KWB/M

This hose package can be used in combination with blastpot option 'Pc'. The hose package is delivered complete with blast hose, twin hose, water hose, couplings, nozzle holder, deadman handle type G2 and wet blast attachment type KWB.

A nozzle is not included.

This KWB attachment is suitable for all nozzles with 50 mm coarse thread. A pump unit is necessary to mix the water and air/media inside. Because of the pump unit the metering of the water can be set very accurate. Also heights or extreme hose lengths are not a problem. Delivered complete with stop and regulator valve.

10 meters

Hose package 'wet', KWB/M, 3/4" blast hose	18600510
Hose package 'wet', KWB/M, 1" blast hose	18600610
Hose package 'wet', KWB/M, 1 1/4" blast hose	18600710

20 meters

Hose package 'wet', KWB/M, 3/4" blast hose	18600520
Hose package 'wet', KWB/M, 1" blast hose	18600620
Hose package 'wet', KWB/M, 1 1/4" blast hose	18600720

'KWB/M' wet blast attachment only

'KWB/M' c/w regulator valves	15070020
------------------------------	----------



Functions with



(more info on page 18)

3s

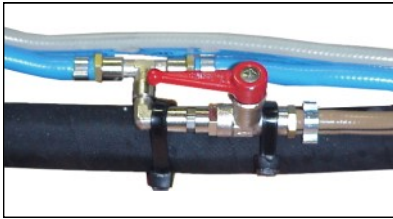

3rd signal on hose package

With this function the abrasive metering valve can be shut by the operator. Objects can then be cleaned with air (and water) only. Possible for the blastpot types EXC, TH, ECO and MM-A

3 rd signal on hose package	18900000
--	----------



Lashing for hose package

All hose packages and extensions are delivered tied up with lashings. These lashings make it a lot easier to pack, transport and store the packages and extensions. The lashings of 1 meter can also be ordered separately

Lashing, 1 meter	13100100
------------------	----------



Whip check

For a safe connection of the hose package to the machine or hose extension it is strongly advised to use a whip check. In case of e.g. a faulty coupling, the whip check helps to prevent injury if a hose connection separates. The whip checks can also be used for compressed air hoses.

Whip check for hose outer diameter 13-32 mm	WHIPCHECK0
Whip check for hose outer diameter 32-75 mm	WHIPCHECK



Hose cutting tool

When replacing the blast hose it is important to cut the ends straight! This ensures an airtight closure to the coupling and nozzle and avoids excessive quick wear of the coupling or nozzle. With this cutting tool a straight cut of the blast hose is a piece of cake.

Hose cutting tool	CUTTOOL
-------------------	---------

Hose extension 'dry'

This hose extension is suitable for the hose package 'dry' and is delivered complete with blast hose, twin hose and couplings.

extension for:



10 meters

Hose extension 'dry', 3/4" blast hose	18700510
Hose extension 'dry', 1" blast hose	18700610
Hose extension 'dry', 1 1/4" blast hose	18700710

20 meters

Hose extension 'dry', 3/4" blast hose	18700520
Hose extension 'dry', 1" blast hose	18700620
Hose extension 'dry', 1 1/4" blast hose	18700720
Hose extension 'dry', 1 1/2" blast hose	18700820

extension for:



Hose extension 'wet' type L/M (low/middle pressure)

This hose extension is suitable for the hose packages 'WB', 'WIN' and 'KWB/M' and is delivered complete with blast hose, twin hose, water hose and couplings.

10 meters

Hose extension 'wet', L/M, 3/4" blast hose	18800510
Hose extension 'wet', L/M, 1" blast hose	18800610
Hose extension 'wet', L/M, 1 1/4" blast hose	18800710

20 meters

Hose extension 'wet', L/M, 3/4" blast hose	18800520
Hose extension 'wet', L/M, 1" blast hose	18800620
Hose extension 'wet', L/M, 1 1/4" blast hose	18800720

When the hose package is equipped with the '3rd signal' option, the hose extension should be equipped with this option as well.

'3rd signal' on hose extension	18950000
--------------------------------	----------

**Contractors
Choice**



Silicon carbide nozzle UB

The light weight UB nozzles have a very wear resistant silicon carbide lining. The fully polyurethane jacket is shock absorbing to ensure a long lifetime of the nozzle.

The venturi shape of the nozzle accelerates the speed of the abrasive and creates an even blast pattern.

The UB nozzles come with coarse thread/50 mm.

UB-3, 4.8 mm Ø, l = 118 mm	15010003
UB-4, 6.4 mm Ø, l = 146 mm	15010004
UB-5, 8.0 mm Ø, l = 153 mm	15010005
UB-6, 9.5 mm Ø, l = 179 mm	15010006
UB-7, 11.0 mm Ø, l = 207 mm	15010007
UB-8, 12.5 mm Ø, l = 233 mm	15010008



Tungsten carbide nozzle HYDB

The HYDB nozzles have a straight tungsten carbide lining and an aluminum jacket. The HYDB nozzles come with 3/4" BSP thread.

HYDB2, 3.2 mm Ø, l = 45 mm	15000002
HYDB3, 4.8 mm Ø, l = 45 mm	15000003
HYDB4, 6.4 mm Ø, l = 45 mm	15000004
HYDB5, 8.0 mm Ø, l = 45 mm	15000005
Rubber washer	15500002



Boron carbide nozzle BC32

The BC32 nozzles have a very wear resistant hot pressed boron carbide lining and are therefore resistant to all abrasives including aluminum oxide.

The venturi shape of the nozzle accelerates the speed of the abrasive and creates an even blast pattern.

The aluminum jacket has a coarse thread/50 mm.

BC32-4/50, 6.4 mm Ø	15247706
BC32-5/50, 8.0 mm Ø	15247708
BC32-6/50, 9.5 mm Ø	15247710
BC32-7/50, 11.0 mm Ø	15247712
BC32-8/50, 12.5 mm Ø	15247714



Boron carbide nozzle EK-B

The EK-B nozzles have a straight hot pressed boron carbide lining and an aluminum jacket. The EK-B nozzles come with 3/4" BSP thread.

EK-3B, 3.2 mm Ø, l = 45 mm	15020003
EK-4B, 4.8 mm Ø, l = 45 mm	15020004
EK-6B, 6.4 mm Ø, l = 45 mm	15020009
Rubber washer	15500002



Silicon carbide double venturi nozzle

A double venturi nozzle offers a larger blast pattern than a standard venturi nozzle but with a loss in abrasive velocity. These nozzles are suited for jobs where more dispersion of abrasive can be an advantage e.g. for restoration or façade blasting.

These nozzles have an aluminum jacket and come with coarse thread/50 mm.

Double venturi nozzle 6.4 mm	15015004
Double venturi nozzle 8.0 mm	15015005
Double venturi nozzle 9,5 mm	15015006



Boron carbide insert nozzle

The aluminum jacket nozzles have a very wear resistant hot pressed boron carbide lining and are therefore resistant to all abrasives including aluminum oxide.

The venturi shape of the nozzle accelerates the speed of the abrasive and creates an even blast pattern.

The nozzles can be mounted directly into the blast hose.

For 1" blast hose

Insert nozzle 1" x 6,4 mm	15020006
Insert nozzle 1" x 8,0 mm	15020008
Insert nozzle 1" x 9,5 mm	15020010

For 1¼" blast hose

Insert nozzle 1¼" x 8,0 mm	15021008
Insert nozzle 1¼" x 9,5 mm	15021010
Insert nozzle 1¼" x 11,0 mm	15021011
Insert nozzle 1¼" x 12,0 mm	15021012



Boron carbide nozzle XL

For an even higher abrasive velocity there are also three "XL" nozzles available. These have a length of 340 mm(!) and can improve production rates by 15-20%.

The XL nozzles have a very wear resistant hot pressed boron carbide lining and are therefore resistant to all abrasives including aluminum oxide.

The extra long venturi shape of the nozzle highly accelerates the speed of the abrasive and creates an even blast pattern.

The aluminum jacket has a coarse thread/50 mm.

BC32-6/50, 9.5 mm Ø, l = 340 mm	15020306
BC32-7/50, 11.0 mm Ø, l = 340 mm	15020307
BC32-8/50, 12.5 mm Ø, l = 340 mm	15020308



Boron carbide fan nozzles

These unique fan nozzles come with a wear resistant sintered boron carbide liner and steel jacket. With the retaining ring the nozzle can be put in every position wanted, in every coarse thread / 50 mm holder.

The outlet creates a wide blast pattern which is ideal for treating large surfaces and especially for (façade) cleaning applications.

The 16,5 x 2 mm version has the same air consumption as a 6.5 mm round nozzle. The 22 x 2 mm as an 7.5 mm and the 22 x 3 mm as a 9.2 mm round nozzle.

FAN 16,5 x 2 mm c/w retaining ring	15230004
FAN 22 x 2 mm c/w retaining ring	15230005
FAN 22 x 3 mm c/w retaining ring	15230003

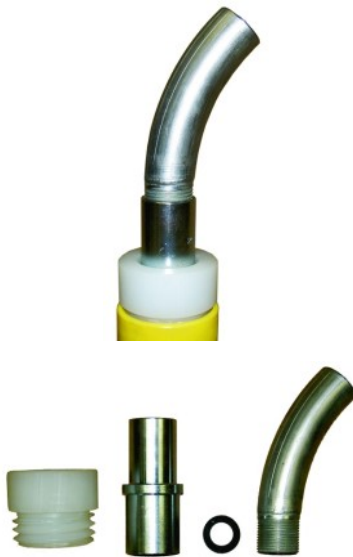

Boron carbide angled nozzles

These unique nozzles come with a 40° angle for hard to reach areas.

The nozzles have a 3/4" BSP connection, a steel jacket and a very wear resistant hot-pressed boron carbide lining.

With the connection piece and retaining ring the nozzle can also be used in a coarse thread / 50 mm holder and can be 'aimed' at every position wanted.

6.0 mm, angled nozzle 40°, 3/4" BSP	15022219/6
8.0 mm, angled nozzle 40°, 3/4" BSP	15022219/8
10.0 mm, angled nozzle 40°, 3/4" BSP	15022219/10
11.0 mm, angled nozzle 40°, 3/4" BSP	15022219/11
13.0 mm, angled nozzle 40°, 3/4" BSP	15022219/13
Rubber washer	15500002
Connection piece	15022509
Retaining ring	15230003WAR



Boron carbide Water Jet Nozzle WJN

The Water Jet Nozzles have a sintered boron carbide lining and an aluminum jacket. The WJN nozzles come with 50 mm coarse thread. The Mini version has 3/4" BSP threading.

Water and air/media is mixed inside the WJN nozzle. For this internal mixing no pump unit is required because of its unique induction design.

For a correct setting of the amount of water a set of stop and regulator valve is advisable. This set is delivered complete with a hose tail to connect to a water hose

Water Jet Nozzle (WJN)

Water Jet Nozzle, WJN-4, 6,4 mm	15300004
Water Jet Nozzle, WJN-5, 8,0 mm	15300005
Water Jet Nozzle, WJN-6, 9,5 mm	15300006
Water Jet Nozzle, WJN-7, 11,0 mm	15300007
Water Jet Nozzle, WJN-8, 12,7 mm	15300008
Set of stop and regulator valve for water	15070030



Wet blast attachment WJN-Mini

This wet blast attachment has a tungsten carbide liner and an aluminium jacket. The attachment should be combined with a 3.2 or 4.8 mm HYDB nozzle. Larger nozzles are not possible.

The WJN-Mini attachment fits over the nozzle and mixes water and air/media before it leaves the tip of the attachment. For this internal mixing no pump unit is required because of its unique induction design. For the correct setting of the amount of water, a set of stop and regulator valve is included.

Wet blast attachment WJN-Mini

WJN-Mini c/w ball valve and regulator	15290005
Nozzle HYDB2, 3.2 mm Ø, l = 45 mm	15000002
Nozzle HYDB3, 4.8 mm Ø, l = 45 mm	15000003
Rubber washer	15500002



Special nozzles

Our different nozzle suppliers have many more possibilities in shapes, sizes and materials. For example nozzles with multiple outlets, 360° outlets, fishtail outlets and different connections etc.

Please contact us for information about the possibilities.

WHAT SIZE COMPRESSOR DO I NEED?

The compressor's capacity in m³/min or CFM is of more importance than its pressure (bar/PSI). This volume capacity must match the set blasting pressure and orifice of the nozzle.

The simple fact, "more power = more production" certainly applies to compressed air blasting. With more compressed air capacity, larger nozzles can be used that provide a large blasting pattern. This way blasting work can be done faster.

COMPRESSED AIR CONSUMPTION

The compressed air consumption of a blasting machine is only determined by the orifice of the nozzle and the set blasting pressure. Type or contents of blast pot or e.g. hose lengths do not influence the consumption.

The following table shows you the compressed air consumption in m³/min with different nozzle orifices and blasting pressures.

Compressed air consumption in m³/min for different nozzles and blast pressures.

	1 bar	2 bar	3 bar	4 bar	5 bar	6 bar	7 bar	8 bar	9 bar	10 bar
Ø 3.2 mm	0.09	0.19	0.28	0.38	0.47	0.57	0.66	0.76	0.85	0.95
Ø 4.8 mm	0.21	0.43	0.64	0.85	1.06	1.28	1.49	1.70	1.91	2.13
Ø 6.4 mm	0.38	0.76	1.13	1.51	1.89	2.27	2.65	3.03	3.40	3.78
Ø 8.0 mm	0.59	1.18	1.77	2.36	2.95	3.55	4.14	4.73	5.32	5.91
Ø 9.5 mm	0.83	1.67	2.50	3.33	4.17	5.00	5.83	6.67	7.50	8.33
Ø 11.0 mm	1.12	2.23	3.35	4.47	5.59	6.70	7.82	8.94	10.05	11.17
Ø 12.7 mm	1.49	2.98	4.47	5.96	7.21	8.93	10.42	11.91	13.40	14.89
Ø 16.0 mm	2.36	4.73	7.09	9.45	11.82	14.18	16.54	18.91	21.27	23.63
Ø 19.0 mm	3.33	6.67	10.00	13.33	16.66	20.00	23.33	26.66	30.00	33.33



Super Mini Tublast (13—30 mm)

The smallest internal pipe blaster has an exchangeable tungsten carbide deflection head which lets out the abrasive from two sides. The head of the Super Mini Tublast is capable of entering pipes of just 13 mm. With extension pipes the deflecting head can be attached to an adaptor nozzle with 3/4" BSP or 50 mm coarse thread. The extension pieces can be delivered with 250, 500, 750 or 1000 mm length. The compressed air consumption of the Super Mini Tublast can be compared to a 6 mm Ø nozzle.

Super Mini Blast, deflection head	24500005
Super Mini Blast, adaptor nozzle 3/4" BSP	24500004
Super Mini Blast, adaptor nozzle 50 mm coarse	24500015
Super Mini Blast, extension pipe 250 mm	24500006
Super Mini Blast, extension pipe 500 mm	24500007
Super Mini Blast, extension pipe 750 mm	24500008
Super Mini Blast, extension pipe 1000 mm	24500009



Mini Tublast (30—100 mm)

This small internal pipe blaster has an exchangeable tungsten carbide deflection tip which spreads the abrasive at 360°. The Mini Tublast is capable of blasting pipes with internal diameters of 30 to 100 mm. It only fits 1/2" blasthose which can be ordered at required lengths. The compressed air consumption of the Mini Tublast can be compared to a 13 mm Ø nozzle.

Mini Tublast	24902000
Blasthose 1/2" (per meter)	16004000



Tublast (75—300 mm)

The Tublast internal pipe blaster comes with an exchangeable wear resistant boron carbide deflection tip which spreads the abrasive at 360°. An internal nozzle of 13 or 16 mm can be selected which will determine the compressed air consumption. It's delivered with various centering collars for small pipe diameters and a centering carriage for blasting larger diameter pipes. This carriage can easily be set to fit different pipes. The Tublast has a standard blast hose coupling connection and can efficiently blast pipes with internal diameters of 76 to 300 mm.

Tublast c/w carriage and 13 mm nozzle	24901050/13
Tublast c/w carriage and 16 mm nozzle	24901050/16



Rotoblast (300—900 mm)

The Rotoblast has a rotating head which is driven by the force of the compressed air escaping the two nozzles. It has a break system to avoid excessive turning speeds of the head.

Different tungsten carbide nozzles can be chosen depending on pipe diameters and compressed air capacities. Boron carbide nozzle are available on request.

The centering carriage comes with different leg lengths so it fits all diameters between 300 and 900mm.

Rotoblast complete with carriage (no nozzles)	24900050
Nozzle 6.4 mm Ø, l = 45 mm (per piece)	15000004
Nozzle 8.0 mm Ø, l = 45 mm (per piece)	15000005
Nozzle 8.0 mm Ø, l = 80 mm (per piece)	24000018
Nozzle 9.5 mm Ø, l = 100 mm (per piece)	24000019



Jumbo Rotoblast (1016—1930 mm)

The Jumbo Rotoblast is the biggest model of the series. It has an extra large rotating head which is driven by the force of the compressed air escaping from the two nozzles. It has a break system to avoid excessive turning speeds of the head.

Different long venturi shaped tungsten carbide nozzles can be chosen depending on compressed air capacities. Boron carbide nozzle are available on request.

The legs of the centering carriage can be set to fit diameters of pipe between 1016 and 1930 mm.

Jumbo Rotoblast c/w carriage (no nozzles)	24502400
Nozzle 6.0 mm Ø, l = 135 mm (per piece)	24502458
Nozzle 8.0 mm Ø, l = 145 mm (per piece)	24502459
Nozzle 9.5 mm Ø, l = 170 mm (per piece)	24502460

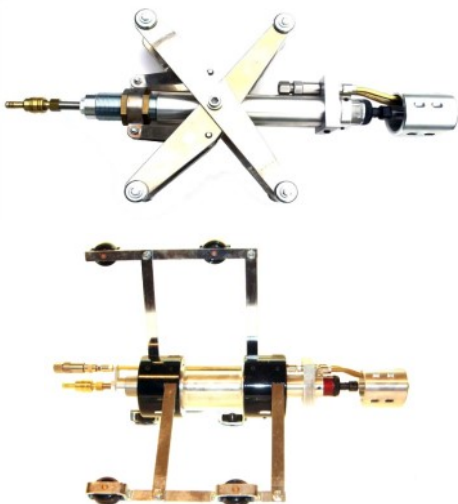

In addition to the internal pipe blast equipment we've got a series of **pipe coaters** available to fulfil your painting needs for pipes of 76 to 900 mm. The air driven rotating head spreads the paint inside the pipe by centrifugal force.

The IPC-125 is delivered with centering collars and different size 'buttons' for small pipe diameters from 76 to 125 mm. The IPC-300 models comes with a centering carriage for painting larger diameter pipes up to 300 mm. This carriage can easily be set to fit different pipes. The IPC-900 has a centering carriage with different leg lengths so it fits all diameters between 300 and 900 mm.

Internal pipe coater IPC-125	24505125
Internal pipe coater IPC-300	24505300
Internal pipe coater IPC-900	24059000



To enable trouble-free blasting the compressed air has to be as dry as possible. Gritco's range of aftercoolers is designed to get the best possible compressed air, for small, mid-sized or large blasting systems.



A SMOOTH ABRASIVE FLOW WITH DRY COMPRESSED AIR

To prevent blast pot blockages, secure a smooth, continuous abrasive flow with lesser breakdowns, wear and maintenance, compressed air needs to be cooled down (approximately at 9°C above ambient temperature).. Because of this drop in temperature, water condenses and forms drops. These drops are removed by the aftercooler's centrifugal separator. For even better clean air-results, optional compressed air filters can be fitted to remove oil and other containments.

The aftercooler is fitted with a pneumatic motor for easy everywhere use. For stationary use or compressed air savings an electric motor in 240V or 400V is available. Connection to the compressor's battery is possible with the 12V DC motor for the two smallest models.

POWERFUL BENEFITS

- Easy (re)moving and installation
- Quick setup in less than a minute
- Optional automatic drainage

BETTER BLASTING VALUE

- Trouble-free blasting production because of 80 - 85% moist extraction
- Nominal capacity model range of 1 or 30 m³/min
- Minimal pressure drops through large pipework
- Wide choice of (optional) oil and containment filters

BETTER BLASTING ECONOMICS

- Saving on abrasive use by better metering possibilities with a smooth continuous abrasive flow
- Avoid costly, poor blasting results caused by wet compressed air

QUALITY INCLUDES

- High quality heat exchanger with copper tubes and aluminium fins
- Durable powder coated finish
- Grid protected cooling fins

Pneumatic versions (air driven motor)

After cooler RA-10-PN, (1.0 m ³ /min), 1"	02021001
After cooler RA-20-PN, (2.0 m ³ /min), 1"	02021002
After cooler RA-40-PN, (4.0 m ³ /min), 1½"	02021004
After cooler RA-65-PN, (6.5 m ³ /min), 2"	02021006
After cooler RA-80-PN, (8.0 m ³ /min), 2"	02021007
After cooler RA-120-PN, (12.0 m ³ /min), 2"	02021008
After cooler RA-160-PN, (16.0 m ³ /min), 2½"	02021009
After cooler RA-200-PN, (20.0 m ³ /min), 3"	02021010
After cooler RA-250-PN, (25.0 m ³ /min), 3"	02021011
After cooler RA-300-PN, (30.0 m ³ /min), DN100	02021012

See next page for the electric versions and all optional extras.



Electric version 12V DC

After cooler RA-10-E12V, (1.0 m ³ /min), 1"	020212V7
After cooler RA-20-E12V, (2.0 m ³ /min), 1"	020212V2
Control and safety switch	020212V3

Electric version 230V

After cooler RA-10-E, (1.0 m ³ /min), 1"	02020001
After cooler RA-20-E, (2.0 m ³ /min), 1"	02020002
Plug with 3 meter cable (incl. mounting)	02STEKKER

Electric version 400-440V

After cooler RA-40-E, (4.0 m ³ /min), 1½" *	02020004
After cooler RA-65-E, (6.5 m ³ /min), 2" *	02020006
After cooler RA-80-E, (8.0 m ³ /min), 2" *	02020007
After cooler RA-120-E, (12.0 m ³ /min), 2"	02020008
After cooler RA-160-E, (16.0 m ³ /min), 2½"	02020009
After cooler RA-200-E, (20.0 m ³ /min), 3"	02020010
After cooler RA-250-E, (25.0 m ³ /min), 3"	02020011
After cooler RA-300-E, (30.0 m ³ /min), DN100	02020012
Motor protection switch incl. 5 m. cable/plug	02020225

* Conversion 400 to 230V

Conversion of models 30 to 80 from 400V to 230V c/w 3 meter cable and a plug	02OMBOUW
--	----------

All mentioned after coolers' capacities in m³/min are based on:

- compressed air inlet temperature of 100°C
- ambient temperature of 25°C
- ΔT of 9°C
- pressure of 7 bar

For any different conditions, please contact us.

Automatic drain for separator

To let off the separated moisture automatically, the aftercooler's cyclone separator can be executed with an automatic float type drain.

Automatic drain for all models, AM-10	02045601
---------------------------------------	----------

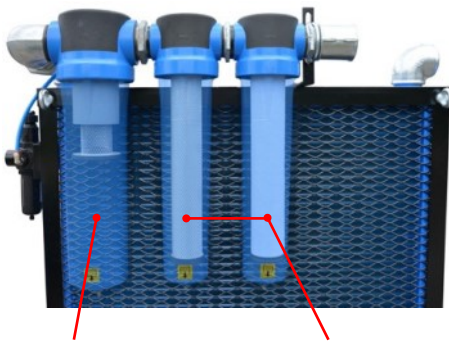

Centrifugal separator (standard)

Optional compressed air filter set



Filter set

In addition to the standard delivered centrifugal separator, the after coolers can be extended with two optional compressed air filters of 5 and 0.01 micron. These remove oil and other contaminants and are advised when (very) fine abrasives are being used or when very high surface cleanliness rates are required.

The filters can be executed with differential pressure indicators which show the state of and when to replace the filter cartridge. Also automatic drains are possible.

Filter set

Filter set for model RA-10 and 20	02FS0010
Filter set for model RA-40	02FS0030
Filter set for model RA-65	02FS0065
Filter set for model RA-80	02FS0080
Filter set for model RA-120	02FS0120
Filter set for model RA-160	02FS0160
Filter set for model RA-200 and 250	02FS0200
Differential pressure indicator (per piece)	02045602
Automatic drain for filter (per piece)	02045601



Low legs

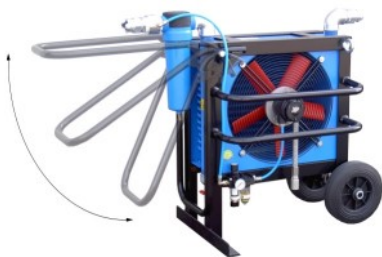

Low frame with wheels



Low frame with forklift openings

Legs and transport frames

The after coolers are supplied as standard on four high sheet steel legs with the separator placed under the cooling block. These legs can also be mounted in such a way that the whole is lowered and therefore a lot more stable (= "low legs" execution).

A sturdy transport frame, however, is recommended when the after-cooler is regularly used at different locations. The powder-coated frame also offers extra protection for the motor and the cooling block itself.

The frames for the models 30, 40, 65, 80 and 120 come with wheels and a push handle which can be folded away. The frames for the models 160, 200, 250 and 300 come with forklift openings.

"Low legs" execution

For models 10, 20, 40, 65 and 80	020212V5
----------------------------------	----------

Transport frame with wheels

For models 40	02301001
For models 65 and 80	02301004
For models 120	02301005

Transport frame with forklift openings

For models 160	02301006
For models 200, 250 and 300	02301007



ASTRO ECONOMIC BLASTING HELMET

Blasting helmet designed to optimize comfort, safety and productivity, with the familiar square (glass) lenses.

The RPB ASTRO is the undisputed economical champion of the abrasive blasting world. Meeting safety standards worldwide, this classic flat lens design is part of RPB's DNA.

The ASTRO offers low lifetime maintenance and part replacement costs, offering you unbeatable value and return on investment without compromising your safety.

POWERFUL BENEFITS

Large visor lens for widened field of view

Streamlined air deflection system distributes air across your breathing zone and across the lens to prevent fogging

BETTER BLASTING VALUE

Without the breathing tube this helmet only weighs 1.2 kg

No sliding down, yet easily replaced cape secured with 8 snap fasteners

QUALITY INCLUDES

Manufactured from robust U.V. stabilized and abrasive resistant material

All attached parts are separately available and easily replaceable

BETTER BLASTING ECONOMICS

Increased productivity due to easy replacement of lenses and availability of tear-off lens system

Use of optional glass outer lenses cut down costs of use



CE 2797

EN14594:2005 3B
RESPIRATORY PROTECTION

Blasting helmet ASTRO

Blasting helmet 'ASTRO'	02-800-CE
Safety inner lens (10 pieces)	02-810
Outer lens, standard (50 pieces)	02-811-015
Tear off lens (50 pieces)	02-816
Outer lens, glass (25 pieces) <i>replaces 02-816 and 02-811-015</i>	02-811-G

Helmet air hose

Helmet air hose, 3/8" (per meter)	16200038
Quick coupler (female)	17102765
Quick coupler (male)	17102775



Head sock

The RPB head socks provide protection from e.g. overspray but can also provides extra hygiene for your blasting helmet.

The soft stretch fabric makes it comfortable to wear and makes one size fits all.

RPB Head Sock (10 pieces)	05-601
---------------------------	--------

Premium Choice



NOVA 3 PREMIUM BLASTING HELMET

Revolutionizing blasting helmet designed to optimize safety and productivity, and to minimize worker downtime.

The revolutionary RPB NOVA 3 helmet minimizes worker downtime and maximizes safe production time through its unrivalled comfort and functionality features.

The helmet's weight is evenly balanced over the head and shoulders which reduces fatigue. In addition a ratchet adjusted neck pad supports the head. With the fully adjustable 'clever fit padding' the helmet can be customized to a perfect individual fit, protecting not only the workers' head and vision but also the hearing.

POWERFUL BENEFITS

Increased productivity with tear-off-lens system ensures the removal of just one lens at the time

Minimal downtime because of (patented) inner-lens system which can be easily operated wearing leather gloves

Optimal downward and peripheral vision through large(r) window

Easy to locate and use, large glove-sized latch

BETTER BLASTING VALUE

Reduced pressure points and an evenly balanced helmet weight through the moulded head liner (making the NOVA 3 the best balanced helmet available)

Full customizing possibilities with the adjustable back-neck support
Increased hearing protection and comfort because of moulded side pads encasing the ears

No sliding down, yet easily replaced cape secured with 8 snap fasteners

Reduced lens fogging and maximum (breathing and cooling) airflow, also through vents in the top dome

QUALITY INCLUDES

Built to resist harsh conditions with a high pressure injection moulded Nylon helmet shell

All attached parts are easily replaceable with just one hex lock key located inside the helmet

BETTER BLASTING ECONOMICS

Over 45 minutes recorded time saved per day (per worker) and increased productivity because of the unique 'fit-and-save' tear-off lens system with pre-folded tabs.

CE 2797

**EN14594:2005 3B
EN12941:1998
+A2:2008 TH3 P R SL
RESPIRATORY PROTECTION**

**EN397:2003+A1:2009
HARD HAT PROTECTION
Impact Clauses**

**EN166:2001 CLASS 1B
EYE & FACE PROTECTION**

Blasting helmet NOVA 3

Blasting helmet 'NOVA 3'	NV3-711-50
Blasting helmet 'NOVA 3' c/w C40 (see page 38)	NV3-715-50
Safety inner lens (10 pieces)	NV3-722
Outer lens (50 pieces)	NV3-724
Tear off lens (50 pieces)	NV3-725

Helmet air hose

Helmet air hose, 3/8" (per meter)	16200038
Quick coupler (female)	17102765
Quick coupler (male)	17102775



RPB NOVA TALK (only for NOVA 3)

Maximized safety levels, improved blasting experience and increased productivity through the wireless communication system which is compatible to most radio systems. NOVA TALK enables constant contact with crewmembers working in remote or secluded areas such as tanks, water towers, etc. on shipyards, sites, etc. The NOVA TALK can also be used to enhance operator training.

- Compatible with any NOVA blast helmet without modification
- Noise cancelling microphone
- Push-to-talk for easy communication
- Optional chest harness for radio
- Compatible with most radios



TALK upgrade kit for NOVA 3	09-903
-----------------------------	--------

The NOVA Talk upgrade kits require a connection cable for the radio being used. The correct cable depends on the brand and type of system. Please contact us for more information.



RPB L4 Light (only for NOVA 3)

Operating at full efficiency using both hands in dark areas (tanks, etc.) because of a highly concentrated, powerful LED light integrated in the helmet enlightening the path of vision like broad daylight. The light is powered by a strong rechargeable Li-ion battery, so no more hassle with electric cables in the blasting area.

The light is mounted on top of the helmet and thus follows the movement of the head and therefore the field of vision of the blaster. As a result, the blaster also has light when leaving the blasting area. The L4 unit comes with an easy field-replaceable outer lens to ensure a good light output over-and-over again.

- Efficient, high powered LEDs producing up to 650 lumens of concentrated light output
- Battery lasts up to 6 hours on a single charge
- Batteries recharge in 3-4 hours
- Lightweight battery pack mounts to your belt



RPB L4 light	09-502-G
Outer lens blast light L4 (10 pieces)	09-522
Extra battery	09-532-2



RPB Radex filters

The RPB Radex is a robust and versatile airline filter with exceptional filtration capacity. The large, 6-stage filter cartridge removes moisture, odor and particulates to 0.5 micron from the compressed air stream, providing clean, safe, breathable air.

The Radex is versatile in use with the unique twist and lock wall and floor mounting system. The outlet pressure regulator provides the ability to adjust the air pressure for maximum 2 or 6 users.

RPB Radex filters

Radex airline filter - 2 outlet system	04-900
Radex airline filter - 6 outlet system	04-906
Radex auto drain unit (for wall mount only)	04-924
Radex replacement filter cartridge	APF3100

Filter cases

Three separated filters are housed in a strong plastic case which can be floor or wall mounted. The correct air pressure for two or four users can be set with the built-in pressure regulator.

Emulsions and solid particles (up to 5 micron) are intercepted by the first filter. Liquids and solids (up to 0.1 micron) are caught by the second (coalescing) filter. A remaining oil content of 0.01 mg/m³ makes the air passing these two filters practically 99,99% oil free.

The standard automatic drains on both filters remove moisture, expanding the lifespan of the filter cartridges. Two pressure differential indicators show when the two cartridges need to be replaced.

The third (activated carbon) filter remove all odors and vapors that are still left after the first two filtering stages through the absorbing principle.

These three filter stages result in a remaining oil content as little as 0,008 mg/m³.

EN 12021



Filter cases

Filter case - 2 outlet system	02700003
Replacement filter element QE-0005 (1st stage)	02040050
Replacement filter element HE-0005 (2nd stage)	02042250
Replacement filter element CE-0005 (3rd stage)	02043350

Filter case - 4 outlet system	02700004
Replacement filter element QE-0010 (1st stage)	02040051
Replacement filter element HE-0010 (2nd stage)	02042251
Replacement filter element CE-0010 (3rd stage)	02043351



RPB C40 Climate Control Device

The RPB C40 is an advanced temperature control system for supplied air respirators. The C40 can cool incoming air by up to 29°C (52°F) or heat it by up to 18°C (33°F) meaning you can stay comfortable in even the most extreme temperatures. Adjust your incoming air to the temperature that suits you by simply sliding the lever.

You can increase or decrease airflow with the flow control dial. The device is lightweight and ergonomically designed to sit comfortably on the operator's hip. Low maintenance is required with the air silencers the only parts that need cleaning or replacing.

- Weighs only 277g (excluding belt)
- With the slide of a lever, operators can easily set the rate of heating of cooling
- Increase or decrease airflow with the flow control dial
- Air inlet swivels 360 degrees to ensure the device sits comfortably on your hip

RPB C40 Climate Control Device	03-502
--------------------------------	--------



RPB Cold and Hot Air Tube

The RPB Cold air and Hot air tube are part of RPB safety's range of economical climate control assemblies. They significantly cool/warm your air supply for optimum performance and comfort.

the cold air tube cools compressed breathing air entering respirators by as much as 18°C (32°F). The hot air tube the breathing air entering respirators by as much as 17°C (30°C).

Adjusting the outgoing air temperature to the worker's preference can be done by the airflow regulator. The unit can be easily disassembled for cleaning and maintenance purposes with just as easily replaceable components.



Cold air tube	4000-01CE
Hot air tube	4000-20CE



RPB GX4 Gas Monitor

Have complete confidence that your incoming supplied air is safe with the RPB GX4 Gas Monitor. The GX4 can detect up to four gases simultaneously, and displays data in real time. Currently available sensors include CO, O2 and H2S.

- Connect to the GX4 from your laptop, tablet, phone or network to view real time data, download logs, or air quality reports
- Illuminated display shows real time gas levels
- 103DBA alarm
- Complete quick and easy calibration checks
- Auxiliary connection
- Pre-calibrated sensors available include CO, O2 and H2S
- Optional carry case available for protection of the device

GX4 Gas Monitor

GX4 Gas Monitor (no sensors included)	08-400-G
Carbon monoxide sensor cartridge	08-420-01
Hydro sulfide sensor cartridge	08-420-03
Oxygen sensor cartridge (19.5 - 23.5 %)	08-420-04
Heavy Duty field case	08-424
AUX Strobe light and alarm with 15 meter cable	08-436



The PX5 is an easy way to catch clean breathing air, right at your side: no long airlines required!



PX5 Powered Air Purifying Respirator (PAPR)

Not every blasting application needs a compressed air supply to the blasting helmet. When enough clean ambient air is available, breathing air for the blaster can also be realized with the PX5 unit. Think for example of outdoor blasting, facade restoration, soda blasting etc. The PX5 cannot be used in enclosed spaces such as blasting rooms!

Air is drawn through air inlet scallops by an ultra-efficient, multi-speed fan. To enhance the cartridge's life-time, large particles are removed by a pre filter before the air is circulated through the cartridge. The PX5 is right at your side to provide high quality, purified fresh air.

- Lightweight - complete system weighs just 1160 grams.
- Battery lasts 8 to 12 hours depending on settings and conditions.
- The battery is sealed inside the unit so it will not disconnect or bump off while operating.
- The filter media removes up to 99.97% of particulates down to 0.12 microns.
- LED user interface indicates airflow, fan speed and battery level.
- Alarming - visual, audible, and vibrating alarms alert the user to low battery level, or when airflow falls below the minimum requirements due to the filter needing replacing, or an obstructed airflow.

PX5 PAPR

PX5 PAPR starter pack	03-801-EUUK
Breathing tube for NOVA helmets	04-831
PX5 Pre Filter (10 pieces)	03-890
PX5 High Efficiency Filter Cartridge	03-892-P



Leather reinforced blasting overall

These heavy duty blasting overalls are tested according to EN ISO 14877 (*protective clothing for abrasive blasting operations using granular abrasives*).

The leather reinforced parts of the cotton overall ensure the best protection during the harshest blasting conditions.

- Leather reinforced fronts of sleeves & legs
- Leather elbow pieces and a leather collar
- Closure with press studs and protective cover with Velcro
- Velcro straps at wrist and ankle cuffs

Leather reinforced blasting overall size S (50)	12200018
Leather reinforced blasting overall size M (52)	12200019
Leather reinforced blasting overall size L (54)	12200020
Leather reinforced blasting overall size XL (56)	12200021
Leather reinforced blasting overall size XXL (58)	12200022
Leather reinforced blasting overall size XXXL (60)	12200023



RPB Heavy duty suit

The lightweight RPB suit provides protection against abrasive rebound. Made from heavy duty nylon to provide protection to the front of your body and arms, with a breathable cotton back to help keep you cool.

- Triple stitching for durability
- Optional knee pads
- Robust nylon zipper with protective cover
- Elasticated waist for a comfortable fit
- Elasticated wrists and adjustable ankle cuffs
- Interior pocket

RPB Heavy duty suit, size S	07-755-S
RPB Heavy duty suit, size M	07-755-M
RPB Heavy duty suit, size L	07-755-L
RPB Heavy duty suit, size XL	07-755-XL
RPB Heavy duty suit, size XXL	07-755-XXL
RPB Heavy duty suit, size XXXL	07-755-XXXL
RPB Heavy duty suit, size XXXXL	07-755-XXXXL
Knee pads	07-761



Leather gloves

The RPB Leather Gloves provide protection from abrasive rebound.

They are made from premium quality leather with Kevlar® stitching for durability, and feature a double layer palm for additional protection from wear, and a soft comfortable lining.

The gloves come in one size.

Double palmed leather gloves	12050001
------------------------------	----------



Gritco's extraction units offer easy to move and quickly installed possibilities to contain dust and other pollution to the actual blasting area. Automatic cleaning of the filter cartridges result in a minimum pressure drop and a constant extraction capacity."



Model shown with optional silencer



CLEAN WORKING CONDITIONS: EASY SET UP EXTRACTION UNIT

In order to avoid environmental hinder, actual blasting areas are often sealed off by scaffolding and tarpaulin covers. Smaller objects can e.g. be blasted inside containers. Of course dust, abrasive and pollution need to be contained to these (temporary) blasting areas. Gritco's Filter Units create a vacuum and a sufficient air flow that keep these products in the closed off blasting area and can be easily collected.

POWERFUL BENEFITS

- Setup done in minutes
- Easy disposal of dust in hoppers with plastic bags or big bags
- Great mobility with forklift openings and lifting lugs
- Can be transported with standard size trucks
- Automatic cleaning of filter cartridges including after cleaning mode
- Clear indication of cartridge replacement need

BETTER BLASTING VALUE

- Constant extraction capacity ensured by low pressure drop
- Enhanced filter cartridge lifetime thanks to built-in pre-separator and filter fabric
- Silent operation because of ventilator silencer (optional)
- Standard extraction capacities ranging from 3.000, 6.000, 9.000, 12.000 and 18.000 m³/h
- Static pressures of 2.000 to 3.000 Pa

ENVIRONMENTALLY FRIENDLY

- Filter unit keeps working area surroundings free from dust, abrasive and pollution
- Contamination is contained to blasting area and can be easily removed
- Lower energy use and CO₂ emission because of low pressure drop over the filter

QUALITY INCLUDES

- Durable powder coated finish
- Multi micro fiber cartridges each covering 23.6 m² of filtering surface
- Filter load on cartridges of just 1.06 m³/m²/min
- Cleaning rate of 99.9%
- Maximum dust emission of 3 mg/ Nm³

Mobile dust extractors

Mobile filter unit P2/23/3000, 3000 m ³ /h	40701001
Mobile filter unit P4/23/6000, 6000 m ³ /h	40700001
Mobile filter unit P6/23/9000, 9000 m ³ /h	40701002
Mobile filter unit P9/23/12000, 12000 m ³ /h	40701003
Mobile filter unit P12/23/18000, 18000 m ³ /h	40701004

The correct air speed and -changes make for a good working view during the blasting process. Key factor is the right filter capacity (in relation to the blasting area volume). We will gladly help you to choose the right filter capacity.

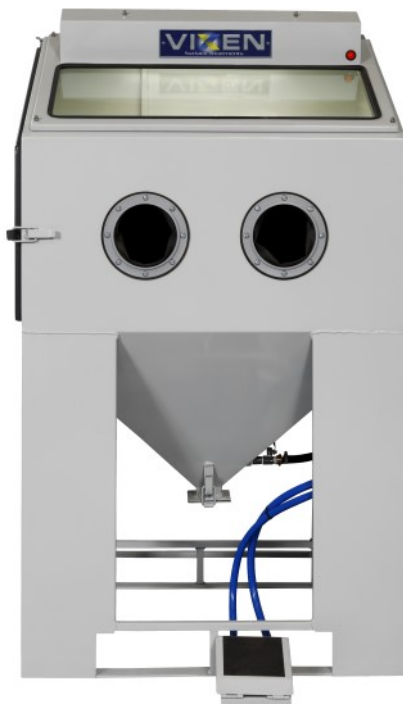

THE PERFECT ADDITION TO ANY (OVERHAUL) WORKSHOP

Suction feed cabinets are suitable for a wide range of different projects varying from pre-repair rust- and/or paint removal to pre-revision cleaning and/or polishing.

Good visibility and effective dust containment is achieved by the powerful dust extracting system. Depending on the abrasive type and application, dust extraction can be optimized by applying automatically cleaned filter cartridges or a cyclone separator.

POWERFUL BENEFITS

- Easy start/stop blasting with large foot pedal
- Good working view through full width window and effective extraction
- Sufficient access possibilities with large side-door
- Easy disposal of collected dust in hopper

BETTER BLASTING VALUE

- Easy changing of different abrasives through quick discharge hatch
- Optimal surface preparing for further painting- and glueing processing
- Adds a nice cosmetic finish

QUALITY INCLUDES

- Wear resistant blasting gun, nozzle and hoses
- No dust and/or abrasive pollution of the surrounding (work) area
- Durable, powder coated cabinet and extractor



	FOX 50	VM 42 / VM 42+	VM 55
<i>Blast room</i>	L = 910 mm W = 700 mm H = 740 mm	L = 1070 mm W = 760/1070 mm H = 760 mm	L = 1400 mm W = 910 mm H = 910 mm
<i>Window</i>	780 x 310 mm	785 x 330 mm	785 x 330 mm
<i>Max object weight</i>	50 kg	70 kg	500 kg
<i>Blast control</i>	Full width foot pedal	Full width foot pedal	Full width foot pedal
<i>Electrics</i>	220V, 1 ph, 50 Hz	220V, 1 ph, 50 Hz	220V, 1 ph, 50 Hz
<i>Dust extraction</i>	Integral 3 pocket filter bag unit	Integral auto cleaned cartridge filter	Integral auto cleaned cartridge filter
<i>Standard extras</i>	Separate air gun	Separate air gun Air filter Pressure reducer	Separate air gun Air filter Pressure reducer

Suction feed blast cabinets

Blast cabinet FOX 50	25010150
Blast cabinet Jetair VM 42	25010142
Blast cabinet Jetair VM 42+	25010142+
Blast cabinet Jetair VM 55	25010155

Options, VM series only

Turntable 25 kg, Ø 450 mm	25045025
Turntable 25 kg, Ø 600 mm	25060025
Turntable 80 kg, Ø 600 mm	25060080
Trolley for turntable with "rocking rails"	25080010
Trolley for turntable, rails on chassis with wheels	25080020



FASTER AND MORE POWERFUL BLASTING WITH THE DIRECT PRESSURE METHOD

Pressure feed cabinets are very effective for blasting large quantities of parts removing heavy pollution, coating or mill scale. Realizing a 5 to 10 times higher output (compared to suction feed) direct pressure cabinets operate with one hose connected to the blast nozzle. Gritco's unique small blast pot is placed directly under the hopper. It pressurizes the abrasive equal to the transportation air pressure, the abrasive simply 'falls' into this air stream and is propelled towards the object. In this way the compressed air is only used for transporting the abrasive (without having to suck it up as well) realizing a very effective blast process. Good visibility and effective dust containment is achieved by the powerful dust extracting system. Depending on the abrasive type and application, dust extraction can be optimized by applying automatically cleaned filter cartridges or a cyclone separator.

POWERFUL BENEFITS

- Simple setup of blasting pressure and abrasive amount
- Easy start/stop blasting with large foot pedal
- Good working view through full width window and effective extraction
- Sufficient access possibilities with large side-door
- Easy disposal of collected dust in hopper

BETTER BLASTING VALUE

- Realizing a 5 to 10 times higher work speed (compared to suction)
- All abrasives can be used, also the 'heavy ones' like steel shot or chilled iron grit

QUALITY INCLUDES

- Wear resistant abrasive metering valve and blasting nozzle
- No dust and/or abrasive pollution of the surrounding (work) area
- Durable, powder coated cabinet and extractor
- Rubber lining protects cabinet- and abrasive from wear

BETTER BLASTING ECONOMICS

- Affordable pressure blasting for most industrial branches because Gritco's special mini blast pot is placed directly under the hopper
- Eliminated production down time through better pre-treatment

Pressure feed blast cabinets

Blast cabinet FOX 50 P	25010150P
Blast cabinet Jetair VM 42 P	25020142
Blast cabinet Jetair VM 42+ P	25020142+
Blast cabinet Jetair VM 55 P	2501055P

Options, VM series only

Turntable 25 kg, Ø 450 mm	25045025
Turntable 25 kg, Ø 600 mm	25060025
Turntable 80 kg, Ø 600 mm	25060080
Trolley for turntable with "rocking rails"	25080000
Trolley for turntable, rails on chassis with wheels	25080020



DUST FREE DEGREASING AND BLASTING IN ONE OPERATION WITH THE SMOOTHEST SURFACE FINISH RESULTS

Wet blasting cabinets are ideal for high spec degreasing and blasting of stainless steel and aluminum objects with a super smooth finish in one single operation.

Extra smooth surface results (compared to dry blasting) with no 'bouncing' abrasives and more processed surface results with the water/media slurry that is transported by the glandless polyurethane pump from the cabinet sump to the blast gun where compressed air is added.

No pre-cleaning, a dust free finish and diminished 'abrasive impregnation risk' because detergents can simply be added to the wet-blasting slurry.

POWERFUL BENEFITS

Optimal working view through full width window, with screen wiper and wash facility

Sufficient access possibilities with large side-door

Safe, single footswitch operation

Easy maintenance because of quick release pump design

BETTER BLASTING VALUE

Degreasing and blasting in one operation

Dust free process

Diminished risk on 'media impregnation'

Smoothest surface finish results for extra product value

Best results for the food industry. Lowest SRI and Ra values

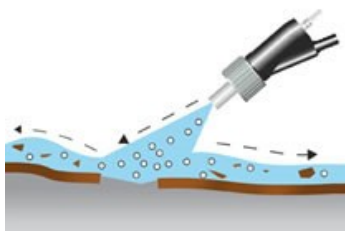

QUALITY INCLUDES

Sturdy, full stainless steel construction

Wear resistant polyurethane pump with stainless steel inlet filter

Extensive option possibilities

ENVIRONMENTALLY FRIENDLY

Just a little fresh water is needed to rinse the gun and wash the window, the actual blasting requires no water

Recycled water from the sedimentation filter for window washing and gun rinsing can be provided by the optional closed loop system



AquaBlast wet blast cabinets

AquaBlast 915	(915 x 880 mm)	25800915
AquaBlast 1215	(1215 x 1180 mm)	25801215
AquaBlast 1515	(1515 x 1480 mm)	25801515

AquaBlast options

Closed loop system	25830000
Media concentration monitor	25850028
Turn tables and mobile trolleys	On request

Contact us for all other possible options.



MiniPro GloveBox version



GloveBox standard series



BLASTING/CLEANING WITHOUT AFFECTING THE SURFACE

Soda blasting cabinets are designed for safe and effective high spec cleaning without affecting the object's surface and are ideal for moulds, engines, etc.

As the – one time use – soda blasting media disintegrates on impact, much dust is produced (compared to using conventional abrasives). To maintain good visibility and a dust- and problem free operation, Gritco's GloveBox cabinets are fitted with a specially designed extraction system that removes all used abrasives, dust and contamination.

The most precise and controlled Soda blasting media metering is realized with Gritco's MicroStrip blast pot. The cabinet can be custom build to meet specific object size, - shape or weight requirements. Different (semi) automation steps can also be realized.

POWERFUL BENEFITS

Good working view through full width window and effective dust extraction

Sufficient access possibilities with large side-door

Easy disposal of collected dust in two hoppers with plastic bags

Automatic filter cartridge cleaning

BETTER BLASTING VALUE

Blasting/cleaning without affecting the surface

One-time-use soda prevents re-contamination of objects

Clear, prolonged visibility and dust free operation ensured by pre-separator cyclone and automatic filter cleaning

One-go-only cleaning process saves time

QUALITY INCLUDES

No workshop pollution from dust and pollution through specially designed dust extractor

Durable powder coated cabinet and extractor

Specially designed MicroStrip blast pot for efficient and cost effective soda blasting

ENVIRONMENTALLY FRIENDLY

No use of water or chemicals

Used soda media is easy to dispose of

MiniPro GloveBox (cabinet, filter unit)

MiniPro GloveBox (600 x 600 mm)	13GBPP10
---------------------------------	----------

GloveBox (cabinet c/w turntable, switchbox, separator/filter unit)

GloveBox 800 (800 x 800 mm)	13GBPP30
GloveBox 1000 (1000 x 1000 mm)	13GBPP50
GloveBox 1200 (1200 x 1200 mm)	13GB1200
GloveBox 1500 (1500 x 1500 mm)	13GB1500

Additional delivery machine (see page 5)

MicroStrip machine MM18-A	23250010
MicroStrip machine MM40-A	23250015
MicroStrip machine MM60-A	23250001

For more information about larger models, options and special executions please contact us.



INDUSTRY'S LEADING BAKING SODA-BASED ABRASIVE

ARMEX soda blast media is the industry's leading baking soda-based abrasive to remove coatings and contaminants without damaging or distorting a wide variety of substrates. Including metal, wood, stone, carbon fiber and even glass.

Soda blasting is very effective for cleaning and depainting if (one or more of) the following applies:

Absolutely no surface roughening (which excludes the use of conventional abrasives)

No damaging or affecting surrounding rotary and/or hydraulic parts (because of the soda abrasive's softness)

No residue (in engines, process installations, etc.) as ARMEX is 100% water soluble



POWERFUL BENEFITS

The MicroStrip blast pots are especially developed for the most efficient, cost-effective use of ARMEX Soda Abrasive

To suit any application, ARMEX Soda Blast media comes in 3 different particle sizes

- Maintenance: for general cleaning purposes
- Maintenance XL: highly effective paint removal because of 4x larger crystals (as in basic Baking Soda)
- Anilox/Composite: the finest grade for (the most) delicate substrates like fiberglass and fine lined anilox rolls

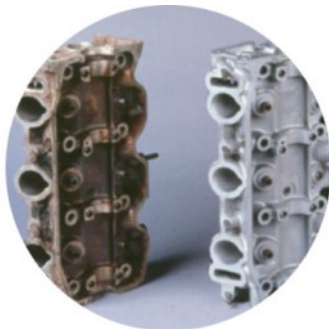

BETTER BLASTING VALUE

Unlike hard abrasives, ARMEX' soft and friable crystals will not damage bearings, seals or other moving components

Quick, clean surface exposure (without metal removal or crack closure) for Non Destructive Inspection and -Testing

Maximized coating performance through superior contaminant removal

Can be used in hazardous duty areas because of non-sparking and non-flammable formulations



QUALITY INCLUDES

ARMEX is more than ordinary Baking Soda. It is a Sodium Bicarbonate abrasive especially composed for blasting purposes

Uninterrupted operation (especially in humid environments) is assured by the protective additives in ARMEX eliminating clumping and clogging issues



ENVIRONMENTALLY FRIENDLY

Compared to solvents-, caustic chemicals-, high pressure water- and sandblasting, the (no free silica containing) ARMEX media provide a superior worker- and environmental safety profile

USDA-approved, A-1 cleaner suitable for use in FDA-regulated facilities

ARMEX Formulas

Maintenance (± 170 micron) <i>bag 50 lb = 22.68 kg</i>	35520001
Maintenance (± 170 micron) <i>pallet 50 bags = 1034 kg</i>	35520001P
Maintenance XL (± 270 micron) <i>bag 50 lb = 22.68 kg</i>	35520002
Maintenance XL (± 270 micron) <i>pallet 50 bags = 1034 kg</i>	35520002P
Anilox/Composite (± 70 micron) <i>bag 50 lb = 22.68 kg</i>	35520009
Anilox/Composite (± 70 micron) <i>pallet 50 bags = 1034 kg</i>	35520002P



TRY BEFORE YOU BUY! EXPERIENCE YOUR BEST BLASTING SOLUTION YOURSELF

Avoid precious mistakes and do not only gain thorough knowledge of all possible sorts of blasting solutions, but also put them to the test extensively before deciding what is your ideal blasting solution.

ONE AND ONLY IN HOLLAND (AND THE REST OF EUROPE!)

You are more than welcome in our brand new and unique Experience Center to get acquainted with Gritco's wide range of high quality blasting equipment. Experience first-hand what more than 30 years of designing-, developing- and manufacturing has resulted in. And what this could mean for your daily blasting practice.



TRY OUT ALL OF THE AIRBLASTING POSIBILITIES

Suction feed blasting

Vacuum based, multi-functional way of pre- or after blasting objects in blasting cabinets. Often used for repairs or overhaul.

Soda blasting

Baking soda based blasting media removes coatings and contaminants without damaging or distorting the substrate. Suited i.e. for cleaning high quality industrial installations, components and mouldings.

Pressure feed blasting

Most effective and efficient blasting method for removing the heaviest forms of pollution, coatings, mill scale or welding discolouring and/or treating large objects or series of parts. Big variety of air pressure blasting pots but also of air pressure blasting cabinets.

Fine blasting

Precisely controlled constant dosage of the finest blasting media at low blasting pressure. Very well suited for wood blasting, façade & monument cleaning and fire damage.



Wet/vapour blasting

Blasting and degreasing at the same time in a blasting cabinet for a high quality, smooth finish of Stainless Steel and aluminium objects. Wet air blasting causes less dust when using blasting pots (without blasting cabinets).

Vacuum blasting

Vacuum, or dust free blasting is suited for spot repairs, welding seams and/or in-situ blasting in working environments where dust - and abrasive pollution is to be avoided.

Gritco Equipment BV

Florijnstraat 93

2988 CL Ridderkerk

The Netherlands

+31 (0)180 412 855

info@gritco.com

