



*Protecting you for
life's best moments.*

Respiratory Protection

Positive and Negative Pressure



GVS is a global manufacturer of filtration devices for the medical and life sciences, energy and mobility, and health and safety sectors.

With our Health & Safety Division, we are specialists in respiratory protection, and we are committed to protecting you for life's best moments.

Protecting people is at the heart of everything we do at GVS. For over forty years, we've been serving the industrial market, collaborating with world-renowned engineers, and constantly pushing the boundaries of creativity with new technologies that improve the functional features of our products, while seeking input from our end-users and refining our range to create the best respirators in the world.

As our passion for protecting people continues to grow, we have expanded our product range to cover more applications and improve the lives of more people through the acquisition of RPB Safety.



Powered Air

6 PX5® PAPR

Loose-fitting Respirators

12 Z-Link®

28 Z4®

36 T-Link®

42 T200™

48 Nova 3®

Air Supply, Filtration, & Monitoring

54 Radex® Airline Filter

58 GX4® Gas Monitor

62 Supplied Air Flow Control Devices

Tight-fitting Respirators

68 Elipse®

73 Segre

74 Integra®



PX5® PAPR

Respiratory Protection Reimagined



The PX5® PAPR changes the way people experience clean filtered air across multiple industries – from medical and chemical settings, through to the profoundly harsh environments of foundries.

The PX5 is the result of years of product refinement, designed with new functional capabilities that increase your ability to perform, while enhancing your experience of comfort. The PX5 redefines what it means to be a powered air purifying respirator.

Weighing just 2.55lbs (1.16kg) with the HEPA filter fitted, and between 3.63lbs (1.65kg) and 3.74 lbs (1.7kg) with a gas filter fitted, the PX5 allows you to get more out of your day by reducing the effects of fatigue. Through strategically distributing its weight with its vertical mounting position and support from our flexi-belt system, the PX5 contours to your body for maximized comfort and stability.

With sleek considered surfaces, quick release mount lock system and certified for IP65 in use and IP67 with cleaning kit in place, the PX5 enables you to efficiently disinfect the unit, reducing downtime and ensuring the system is ready to protect you again.

The PX5 offers three fan speed settings so you can adjust the airflow to suit your personal preferences and the type of environment/application you're working in, these include 170, 210 and 240lpm.

The PX5 is truly the hallmark of powered air purifying respirator capabilities and their practical application.

NIOSH
APPROVED

Only in conjunction with approved respirator.

US and Global patents pending.

User Interface

Intuitive LED user interface indicates airflow, fan speed and battery level.

Weighing just 2.55lbs (1.16kg) with the HEPA filter fitted, and between 3.63lbs (1.65kg) and 3.74 lbs (1.7kg) with gas filter fitted, the sleek, lightweight, compact design maximizes your experience of comfort.

The PX5 unit attaches to our flexi-belt system (fitted with the decon easy clean belt) via our intuitive vertical mount lock system.

The unit easily removes for quick and simple decontamination process.

Backpack option is available for applications that require a greater range of movement and work across varied angles.



**MADE
IN THE USA**



Visual, audible and vibrating alarms alert you when the battery level is low, or when airflow falls below the minimum requirements, due to the filter needing replacing or when airflow is obstructed.

Sealed inside the unit during operation, the long-life lithium-ion battery is protected from moisture when decontaminating and will not disconnect or bump off while operating.

Ingress Protection - With a completely sealed housing, the PX5 has been certified to IP65 rating in use.

The filter door cannot mount to the unit unless a filter is fixed in place.

The HEPA filter removes up to 99.97% of particulates down to 0.12 microns. The gas filters protect against organic vapor exposure. Replace the pre-filter daily to extend the life of the main filter.

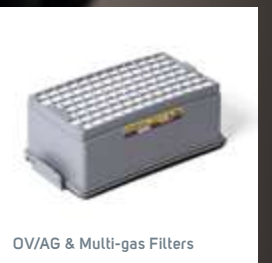

PX5 PAPR Approved Headtops



Z-Link®
Page 12-27

Z4®
Page 28-35



T-Link®
Page 36-41

T200™
Page 42-47

PX5 PAPR Packages

GVS Part #	Description	Certifications
03-801	PX5 PAPR Easy Clean Starter Pack <i>Package also includes:</i> <ul style="list-style-type: none"> Rechargeable battery and charging bank Easy clean belt Flow meter 1x HEPA filter 1x pre-filters (pk 10). 	NIOSH* IP65
03-803	PX5 PAPR Easy Clean Starter Pack with Backpack <i>Package also includes:</i> <ul style="list-style-type: none"> Rechargeable battery and charging bank Easy clean belt with backpack assembly Flow meter 1x HEPA filter 1x pre-filters (pk 10). 	NIOSH* IP65
03-801-FR	PX5 PAPR Industrial Starter Pack <i>Package also includes:</i> <ul style="list-style-type: none"> Rechargeable battery and charging bank FR belt Flow meter 1x HEPA filter 1x spark arrestor 1x pre-filters (pk 10). 	NIOSH* IP65
03-803-FR	PX5 PAPR Industrial Starter Pack with Backpack <i>Package also includes:</i> <ul style="list-style-type: none"> Rechargeable battery and charging bank FR belt with backpack assembly Flow meter 1x HEPA filter 1x spark arrestor 1x pre-filters (pk 10). 	NIOSH* IP65













PX5 PAPR Packages

GVS Part #	Description	Certifications
03-802	 PX5 PAPR Easy Clean Starter Pack for Gas Cartridges <i>Package also includes:</i> <ul style="list-style-type: none"> Rechargeable battery and charging bank Easy clean belt Gas cartridge door Flow meter 1x pre-filters (pk 10). <i>Gas cartridge sold separately.</i>	NIOSH* IP65
03-802-FR	 PX5 PAPR Industrial Starter Pack for Gas Cartridges <i>Package also includes:</i> <ul style="list-style-type: none"> Rechargeable battery and charging bank FR belt Gas cartridge door Flow meter 1x spark arrestor 1x pre-filters (pk 10). <i>Gas cartridge sold separately.</i>	NIOSH* IP65

PX5 PAPR Filters/Cartridges







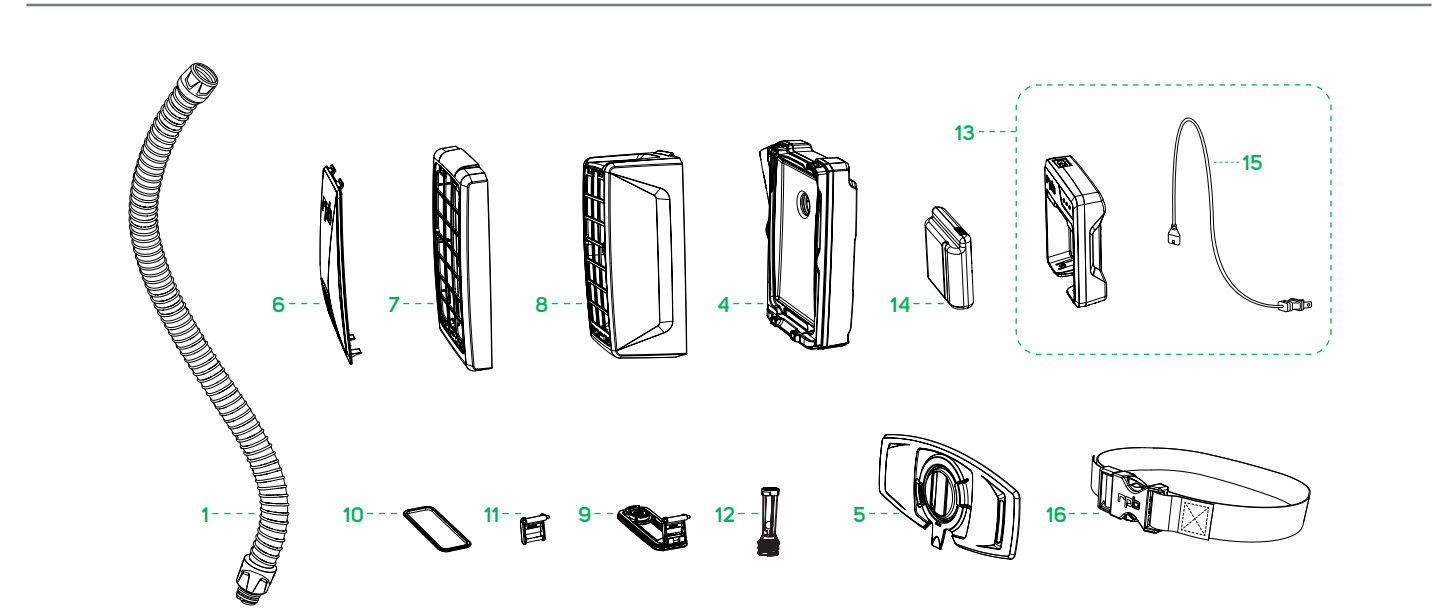

GVS Part #	Description	Certifications
03-890	Pre-filters (pk 10)	
03-891	PAPR Spark Arrestor	
03-892	HEPA Filter	NIOSH - HE
03-893	HEPA OV/AG Gas Cartridge	NIOSH - OV/SD/HC/CL/HF/CD/HE
03-894	HEPA Multi-Gas Cartridge	NIOSH - OV/SD/HC/CL/HF/CD/HS/AM/FM/MA/HE

PX5 PAPR Accessories

GVS Part #	Description	Certifications
03-852	 PAPR 5 Bay Multi-Charger	
03-822-DC	 Back Harness Assembly - <i>Decon/easy clean.</i>	
03-822-FR	 Back Harness Assembly - <i>FR.</i>	
03-841	 Tychem® 4000 PAPR Multi-Gas Cover (pk 10)	
03-842	 Zytec® PAPR Multi-Gas Cover (pk 10)	
04-852	 Tychem® Breathing Tube Cover <i>Breathing tube not included.</i>	
04-854	 FR Breathing Tube Cover <i>Breathing tube not included.</i>	
04-855	 Aluminized Breathing Tube Cover <i>Breathing tube not included.</i>	
04-856	 Disposable/Decon Breathing Tube Sleeve (pk 10) <i>Breathing tube not included.</i>	
04-872	 Short Tychem® Breathing Tube Cover <i>For backpack assembly, breathing tube not included.</i>	
04-874	 Short FR Breathing Tube Cover <i>For backpack assembly, breathing tube not included.</i>	
04-875	 Short Aluminized Breathing Tube Cover <i>For backpack assembly, breathing tube not included.</i>	

PX5 PAPR Parts



	GVS Part # / Description	GVS Part # / Description	
1	 04-831 PAPR Breathing Tube	10	 03-817 Battery Door Seal
-	 04-831A PAPR Breathing Tube with Adaptor <i>To fit T-Link and Z-Link</i>	11	 03-818 Door Hinge
-	 04-841 Short PAPR Breathing Tube <i>For backpack assembly.</i>	12	 03-819 Flow Meter
-	 04-843 PAPR Coupler Seal (pk 5)	13	 03-851 Battery Charger
4	 03-810 Fan Housing	14	 03-855 Battery
5	 03-811 Belt Support Mount	14	 03-856 High Capacity Battery
6	 03-812 Door Cover	15	 09-021 RPB® Power Cable <i>Global plug.</i>
7	 03-813 HEPA (P3) Filter Door	16	 07-765-DC RPB® 2 Inch Belt Assembly <i>Easy clean</i>
8	 03-814 Gas Cartridge Door	16	 07-765-FR RPB® 2 Inch Belt Assembly <i>FR</i>
9	 03-815 Battery Door Assembly <i>Includes 03-818.</i>		

Z-Link® Respirator

Multi-purpose Respiratory Protection



The Z-Link® is the most versatile multi-purpose respirator on the market, designed to be resilient in harsh industrial applications, while also practical to meet the demands of healthcare and life sciences settings. The Z-Link has been created with your comfort and functionality in mind, ensuring no matter where you're working, you'll be protected for your life's best moments.

Visibility has been at the forefront of the Z-Link's design, boasting a large visor that enables you to see with exceptional downward and peripheral vision. This system also combines with a visor that hinges open so you can easily communicate with your team, as and when necessary.

Fitted with a padded headliner and head suspension system, the Z-Link's weight is evenly distributed, relieving you of aches and strains on your neck to enhance your experience of comfort. Being fully adjustable ensures the respirator fits securely to all head sizes, maximizing stability and always moving with your head. Our innovative design ensures you have a greater range of movement, so you can focus on your job at hand. The Z-Link is everything you need in a respirator.

The Z-Link is certified to the standards below:

NIOSH
APPROVED
PAPR & SAR TYPE C

ANSI
S3.19
HEARING PROTECTION
Only in conjunction with 18-533 earmuffs.
Z89.1
HARD HAT PROTECTION
Type 1 Class G
Z87+
EYE & FACE PROTECTION

SEI
Certified Model
Modèle certifié
CSA Z94.3-15
EYE & FACE PROTECTION
Class 7D Respirator Facepiece
PROTECTION DES YEUX ET DU VISAGE
Masque respiratoire classe 7D

Visor hinges open for easy communication with team members (outside of respiratory hazards).

Optimum vision and high velocity impact protection with large optically-clear safety lens (replaceable spare part). Choice of 5 anti-fog and scratch resistant EN166 lenses: Premium Clear, Green Tint (Shade 5), Yellow Tint, Black Tint, and Mirror Tint.

ANSI Z89.1 certified head protection.

Padded interior with adjustable ratchet system ensures a perfect customized fit that supports movement, increasing comfort and productivity.

Air flow and distribution is fully adjustable with the air deflector system to suit your personal preference.

Three cape materials available: Tychem® 2000, Tychem® 4000 or Zyltec® FR.

Fixed jaw ensures secure cape attachment.

Vision-Link™ light mount point.

Superior Comfort

The fully adjustable Comfort-Link™ fit system allows for total control of your sizing through supportive padding and the adjustable 360° head band and ratchet system.



Visor shown open for marketing purposes only. Do not open your visor in the work environment.

Z-Link+® Respirator

Diverse Functionality



The Z-Link+® has been designed to give you all the freedom and comfort that you receive with the Z-Link but extends the respirator's capabilities, giving you eye protection so you can weld without the need for additional systems.

The Z-Link+ weld visor clips on directly to your main visor so you can seamlessly weld with optically clear vision, then lift up the visor to check welds and instantly begin grinding again. With the large GVS-RPB® ADF lens with a 1/1/1/2 optical quality rating, this guarantees uniform shading and distortion free vision, while allowing you to work safely and more comfortably for longer across different angles.

The Z-Link+ is certified to the standards below:

NIOSH
APPROVED
PAPR & SAR TYPE C

ANSI
S3.19
HEARING PROTECTION
Only in conjunction with 18-553 earmuffs.

Z89.1
HARD HAT PROTECTION
Type 1 Class G

Z87+
EYE & FACE PROTECTION

Z87W
WELDING EYE PROTECTION

SEI
Certified Model
Modèle certifié

CSA Z94.3-15
EYE & FACE PROTECTION
Class 7D Respirator Facepiece
PROTECTION DES YEUX ET DU VISAGE
Masque respiratoire classe 7D

The weld visor can be easily removed for extended periods where just grinding is required. ■

■ Large welding auto darkening filter with a 1/1/1/2 rating. Variable auto darkening lens (shades 3, 5, or 9-13). Replaceable impact and ADF lenses for ease of maintenance.

■ Z-Link+ weld visor attaches directly onto to the main grinding visor, enabling you to seamlessly switch from welding to grinding while maintaining respiratory protection.

The Z-Link+ weld visor weighs only 13.8oz (390g) including ADF. ■

Removable Welding Visor

The Z-Link+ weld visor clips directly onto your main visor, enabling you to lift up your visor to check welds and to instantly begin grinding. For extended periods of grinding the visor is easily removed at the hinge points.



Z-Link® Radiant Heat Respirator

Heat Defense



The Radiant Heat kit transforms your Z-Link® respirator into a complete protective system for high heat environments. Utilizing the Z-Link headtop, experience unrivaled comfort as heat is deflected away from you and air continuously circulates throughout the headtop, so you can work safer for longer.

The Radiant Heat kit features a large, gold coated visor that reflects heat off you, keeping your body temperature down, while allowing you to see all of your environment with an uncompromised field of view. With flame resistant and reflective materials this protects you from sparks and splashes while providing additional relief from the heat.

Enhance your experience of safety and productivity in high heat environments by using protection that revolutionizes the way you work, with the Z-Link Radiant Heat.

The Z-Link Radiant Heat is certified to the standards below:

NIOSH
APPROVED
PAPR & SAR TYPE C

ANSI
S3.19
HEARING PROTECTION
Only in conjunction with 18-533 earmuffs.
Z89.1
HARD HAT PROTECTION
Type 1 Class G
Z87+
EYE & FACE PROTECTION

SEI
Certified Model
Modèle certifié
CSA Z94.3-15
EYE & FACE PROTECTION
Class 7D Respirator Facepiece
PROTECTION DES YEUX ET DU VISAGE
Masque respiratoire classe 7D

Gold coated visor reflects radiant heat, minimizing heat transfer for increased comfort while ensuring eye protection. Visor options include anti-scratch gold coated (pictured), anti-scratch IR5 gold coated, and IR5.

Large visor lift tab enables users to easily raise and lower the visor while wearing gloves.

Air flow is dispersed throughout your breathe zone, as well as over the head, neck, and body to aid in cooling.

Integrated hard hat protection.

The Aluminized fabric is flame resistant and protects the skin from sparks, splashes and radiant heat. Manufactured from Newtex Z-Flex O-310 Aluminized FR O-PAN/Aramid fabric.

Clip-on visor requires no tools for easy detachment and replacement.

Secured cape ensures the hood moves with you for a greater range of movement.

Aluminized breathing tube cover available to increase the life of the breathing tube.









Heat Reflection
The gold coated visor reflects radiant heat away from you, minimizing heat transfer while ensuring your eyes are protected.

Z-Link® Respirator









Multi-purpose Respiratory Protection



Z-Link Headtops

GVS Part #	Description	Certifications
16-010-31	 <p>Z-Link Respirator - Zytec® FR Chin Seal Package also includes: ■ Safety lens. Z-Link+ weld visor with ADF available - page 24.</p>	NIOSH PAPR & SAR Type C, ANSI S3.19 ¹ , ANSI Z89.1, ANSI Z87+, ANSI Z87W [†] , c SEI CSA Z94.3-15
16-010-12	 <p>Z-Link Respirator - Tychem® 2000 Face Seal Package also includes: ■ Safety lens.</p>	NIOSH PAPR & SAR Type C, ANSI S3.19 ¹ , ANSI Z89.1, ANSI Z87+, c SEI CSA Z94.3-15
16-010-11	 <p>Z-Link Respirator - Zytec® FR Face Seal Package also includes: ■ Safety lens. Z-Link+ weld visor with ADF available - page 24.</p>	NIOSH PAPR & SAR Type C, ANSI S3.19 ¹ , ANSI Z89.1, ANSI Z87+, ANSI Z87W [†] , c SEI CSA Z94.3-15
16-010-23	 <p>Z-Link Respirator - Tychem® 4000 Shoulder Cape Package also includes: ■ Safety lens.</p>	NIOSH PAPR & SAR Type C, ANSI S3.19 ¹ , ANSI Z89.1, ANSI Z87+, c SEI CSA Z94.3-15
16-010-21	 <p>Z-Link Respirator - Zytec® FR Shoulder Cape Package also includes: ■ Safety lens. Z-Link+ weld visor with ADF available - page 24.</p>	NIOSH PAPR & SAR Type C, ANSI S3.19 ¹ , ANSI Z89.1, ANSI Z87+, ANSI Z87W [†] , c SEI CSA Z94.3-15
16-010-24	 <p>Z-Link Radiant Heat Respirator Package also includes: ■ Safety lens ■ Aluminized shoulder cape, top, rear and breathing tube cover. Lens available in three options, sold separately - page 24.</p>	NIOSH PAPR & SAR Type C, ANSI S3.19 ¹ , ANSI Z89.1, ANSI Z87+, c SEI CSA Z94.3-15

Z-Link SAR Packages Please visit gvs-rpb.com for more information about other package options available.







GVS Part #	Description	Certifications
16-015-11	 <p>Z-Link Respirator with Zytec® FR Face Seal and C40™ Climate Control Device Package also includes: ■ Safety lens ■ SAR breathing tube.</p>	NIOSH SAR Type C, ANSI S3.19 ¹ , ANSI Z89.1, ANSI Z87+, c SEI CSA Z94.3-15
16-015-12	 <p>Z-Link Respirator with Tychem® 2000 Face Seal and C40™ Climate Control Device Package also includes: ■ Safety lens ■ SAR breathing tube.</p>	NIOSH SAR Type C, ANSI S3.19 ¹ , ANSI Z89.1, ANSI Z87+, c SEI CSA Z94.3-15
16-015-21	 <p>Z-Link Respirator with Zytec® FR Shoulder Cape and C40™ Climate Control Device Package also includes: ■ Safety lens ■ SAR breathing tube.</p>	NIOSH SAR Type C, ANSI S3.19 ¹ , ANSI Z89.1, ANSI Z87+, c SEI CSA Z94.3-15
16-015-23	 <p>Z-Link Respirator with Tychem® 4000 Shoulder Cape and C40™ Climate Control Device Package also includes: ■ Safety lens ■ SAR breathing tube.</p>	NIOSH SAR Type C, ANSI S3.19 ¹ , ANSI Z89.1, ANSI Z87+, c SEI CSA Z94.3-15
16-015-31	 <p>Z-Link Respirator with Zytec® FR Chin Seal and C40™ Climate Control Device Package also includes: ■ Safety lens ■ SAR breathing tube.</p>	NIOSH SAR Type C, ANSI S3.19 ¹ , ANSI Z89.1, ANSI Z87+, c SEI CSA Z94.3-15
16-071-21	 <p>Z-Link+ Respirator with Weld Visor, Zytec® FR Shoulder Cape and Constant Flow Valve Package also includes: ■ Safety lens ■ SAR breathing tube.</p>	NIOSH SAR Type C, ANSI S3.19 ¹ , ANSI Z89.1, ANSI Z87+, ANSI Z87W [†] , c SEI CSA Z94.3-15
16-075-21	 <p>Z-Link+ Respirator with Weld Visor, Zytec® FR Shoulder Cape and C40™ Climate Control Device Package also includes: ■ Safety lens ■ SAR breathing tube.</p>	NIOSH SAR Type C, ANSI S3.19 ¹ , ANSI Z89.1, ANSI Z87+, ANSI Z87W [†] , c SEI CSA Z94.3-15
16-0061	 <p>Z-Link Radiant Heat Respirator with Gold Visor and C40™ Climate Control Device Package also includes: ■ Safety lens ■ SAR breathing tube ■ Aluminized shoulder cape, top cover, rear cover and breathing tube cover.</p>	NIOSH SAR Type C, ANSI S3.19 ¹ , ANSI Z89.1, ANSI Z87+, c SEI CSA Z94.3-15

Z-Link® Respirator





Multi-purpose Respiratory Protection



Z-Link PAPR Packages Please visit gvs-rpb.com for more information about other package options available.

GVS Part #	Description	Certifications
16-0011	 <p>Z-Link Respirator with Zytec® FR Face Seal and PX5® PAPR with OV/AG/HE Cartridge <i>Package also includes:</i> ■ Safety lens ■ PAPR breathing tube.</p>	NIOSH PAPR Type C, ANSI S3.19*, ANSI Z89.1, ANSI Z87+, c SEI CSA Z94.3-15
16-0012	 <p>Z-Link Respirator with Zytec® FR Shoulder Cape and PX5® PAPR with OV/AG/HE Cartridge <i>Package also includes:</i> ■ Safety lens ■ PAPR breathing tube.</p>	NIOSH PAPR Type C, ANSI S3.19*, ANSI Z89.1, ANSI Z87+, c SEI CSA Z94.3-15
16-0021	 <p>Z-Link+ Respirator with Weld Visor, Zytec® FR Shoulder Cape and PX5® PAPR with Multi-gas Cartridge <i>Package also includes:</i> ■ Safety lens ■ PAPR breathing tube.</p>	NIOSH PAPR Type C, ANSI S3.19*, ANSI Z89.1, ANSI Z87+, ANSI Z87W ¹ , c SEI CSA Z94.3-15
16-0028	 <p>Z-Link Respirator with Tychem® 4000 Shoulder Cape and PX5® PAPR with Multi-gas Cartridge <i>Package also includes:</i> ■ Safety lens ■ PAPR breathing tube.</p>	NIOSH PAPR Type C, ANSI S3.19*, ANSI Z89.1, ANSI Z87+, c SEI CSA Z94.3-15
16-018-11-FR	 <p>Z-Link Respirator with Zytec® FR Face Seal and PX5® PAPR <i>Package also includes:</i> ■ Safety lens ■ PAPR breathing tube.</p>	NIOSH PAPR Type C, ANSI S3.19*, ANSI Z89.1, ANSI Z87+, c SEI CSA Z94.3-15
16-018-12	 <p>Z-Link Respirator with Tychem® 4000 Face Seal and PX5® PAPR <i>Package also includes:</i> ■ Safety lens ■ PAPR breathing tube.</p>	NIOSH PAPR Type C, ANSI S3.19*, ANSI Z89.1, ANSI Z87+, c SEI CSA Z94.3-15
16-018-21-FR	 <p>Z-Link Respirator with Zytec® FR Shoulder Cape and PX5® PAPR <i>Package also includes:</i> ■ Safety lens ■ PAPR breathing tube.</p>	NIOSH PAPR Type C, ANSI S3.19*, ANSI Z89.1, ANSI Z87+, c SEI CSA Z94.3-15

Z-Link PAPR Packages Please visit gvs-rpb.com for more information about other package options available.

GVS Part #	Description	Certifications
16-018-23	 <p>Z-Link Respirator with Tychem® 4000 Shoulder Cape and PX5® PAPR <i>Package also includes:</i> ■ Safety lens ■ PAPR breathing tube.</p>	NIOSH PAPR Type C, ANSI S3.19*, ANSI Z89.1, ANSI Z87+, c SEI CSA Z94.3-15
16-018-24-GT	 <p>Z-Link Radiant Heat Respirator with Gold Visor and PX5® PAPR <i>Package also includes:</i> ■ Safety lens ■ PAPR breathing tube ■ Aluminized shoulder cape, top, rear and breathing tube cover.</p>	NIOSH PAPR Type C, ANSI S3.19*, ANSI Z89.1, ANSI Z87+, c SEI CSA Z94.3-15
16-018-31-FR	 <p>Z-Link Respirator with Zytec® FR Chin Seal and PX5® PAPR <i>Package also includes:</i> ■ Safety lens ■ PAPR breathing tube.</p>	NIOSH PAPR Type C, ANSI S3.19*, ANSI Z89.1, ANSI Z87+, c SEI CSA Z94.3-15
16-078-11-FR	 <p>Z-Link+ Respirator with Weld Visor, Zytec® FR Face Seal and PX5® PAPR <i>Package also includes:</i> ■ Safety lens ■ PAPR breathing tube.</p>	NIOSH PAPR Type C, ANSI S3.19*, ANSI Z89.1, ANSI Z87+, ANSI Z87W ¹ , c SEI CSA Z94.3-15
16-078-21-FR	 <p>Z-Link+ Respirator with Weld Visor, Zytec® FR Shoulder Cape and PX5® PAPR <i>Package also includes:</i> ■ Safety lens ■ PAPR breathing tube.</p>	NIOSH PAPR Type C, ANSI S3.19*, ANSI Z89.1, ANSI Z87+, ANSI Z87W ¹ , c SEI CSA Z94.3-15

*Only in conjunction with #18-533 earmuffs.
¹Only in conjunction with #16-670 Z-Link+ weld visor.

Z-Link® Respirator

Multi-purpose Respiratory Protection



Z-Link Accessories

GVS Part #	Description	Certifications
04-852	Tychem® Breathing Tube Cover <i>Breathing tube not included.</i>	
04-854	FR Breathing Tube Cover <i>Breathing tube not included.</i>	
04-855	Aluminized Breathing Tube Cover <i>Breathing tube not included.</i>	
04-856	Disposable/Decon Breathing Tube Sleeve (pk 10) <i>Breathing tube not included.</i>	
04-872	Short Tychem® Breathing Tube Cover <i>For backpack assembly, breathing tube not included.</i>	
04-874	Short FR Breathing Tube Cover <i>For backpack assembly, breathing tube not included.</i>	
04-875	Short Aluminized Breathing Tube Cover <i>For backpack assembly, breathing tube not included.</i>	
16-512	Heat Resistant Velcro Fastener Kit	
16-520-S	Comfort-Fit Side Padding System	
18-533	Quiet-Link™ Helmet Mounted Earmuffs <i>Includes 18-535 suspension bracket.</i>	ANSI S3.19
16-670	Z-Link+® Weld Visor <i>Includes 1/1 1/2 ADF Lens.</i>	ANSI Z87W
16-676	Z-Link+® Weld Visor with Fixed Lens Frame <i>Includes 16-674, 16-877 and 16-672, ADF lens not included.</i>	
16-724	Aluminized Shoulder Cape	
16-744	Aluminized Top Cover	
16-754	Aluminized Rear Cover	
16-901	Vision-Link™ Helmet Light Kit* <i>Includes 09-510-RAW, 16-918 and 15-839.</i>	
16-922	Comms-Link™ In-Helmet Communication System* (Non IS) - Includes 16-529 and 09-913. Radio adaptor sold separately - contact GVS-RPB for more information.	
18-535	Quiet-Link™ Suspension Brackets	

Z-Link Consumables

GVS Part #	Description	Certifications
04-831	PAPR Breathing Tube	
04-833	SAR Breathing Tube	
04-833A	SAR Breathing Tube with Adaptor <i>To fit Z-Link and T-Link.</i>	
04-841	Short Breathing Tube <i>For backpack assembly.</i>	
13-072-(1, 1.5, 2 or 2.5)	Ultra Magnifying Lens <i>Available in 1.0, 1.5, 2.0 and 2.5.</i>	
16-526	Head Band Brow Pad	
16-675-GT	Radiant Heat Gold Visor - Clear - Replacement <i>Includes Cover Clip and Retainer Assembly.</i>	ANSI Z87+
16-675-GTIR5	Radiant Heat Gold Visor - IR5 - Replacement <i>Includes Cover Clip and Retainer Assembly.</i>	ANSI Z87+
16-675-IR5	IR5 Visor - Replacement <i>Includes Cover Clip and Retainer Assembly.</i>	ANSI Z87+
16-810	Safety Lens - Clear <i>Anti-fog/anti scratch.</i>	ANSI Z87+
16-810-IR5	Safety Lens - IR Tint, Shade 5 <i>Anti scratch.</i>	ANSI Z87+
16-810-MT	Safety Lens - Mirror Tint <i>Anti-fog/anti scratch.</i>	ANSI Z87+
16-810-ST	Safety Lens - Smoke Tint <i>Anti-fog/anti scratch.</i>	ANSI Z87+
16-810-YT	Safety Lens - Yellow Tint <i>Anti-fog/anti scratch.</i>	ANSI Z87+
16-811	Tear-Off Lens (pk 50)	
16-817	Cassette Lens for Z-Link (pk 10) <i>7 layers.</i>	
16-872	Welding ADF/Fixed Shade Impact Lens (pk 10)	
16-872-AL	Welding ADF Impact Lens– Aluminium Coated <i>Radiant heat.</i>	
16-873	Welding ADF Rear Lens (pk 10)	



*Vision-Link™ and Comms-Link™ parts can be found on page 24-25.

Z-Link® Respirator









Multi-purpose Respiratory Protection















Z-Link Consumables

GVS Part #	Description	Certifications
16-874	 Protective Lens for Aluminium Coated Impact Lens (pk 10)	
16-877	 110x90 Fixed Shade Welding Lens Adaptor Frame	
16-877-(5, 8, 9, 10, 11 or 12)	 Fixed Shade Welding Lens <i>Available in shades 5, 8, 9, 10, 11 and 12.</i>	
16-878	 Welding Fixed Shade Rear Lens (pk 10)	

Comms-Link™ Parts Available for Z-Link®, T-Link® and Z4®

GVS Part #	Description	Certifications
09-913	 Push to Talk Button	
16-529	 Communication Retainer Clip	
09-930	 Motorola Connection Cable - <i>Two-pin.</i>	
09-931	 Motorola Connection Cable - <i>Multi-pin.</i>	
09-932	 Motorola Connection Cable - <i>Multi-pin.</i>	
09-933	 Kenwood Connection Cable - <i>Two-pin.</i>	
09-934	 Motorola Connection Cable - <i>Multi-pin.</i>	
09-935	 Motorola Connection Cable - <i>Single-pin.</i>	

Vision-Link™ Parts Available for Z-Link®, T-Link® and Z4®

GVS Part #	Description	Certifications
09-050	 Two Bay Battery Charger	
09-055	 Lithium Ion Battery	
15-839	 Jaw Mount - for Z-Link, Z4 <i>Screw not included.</i>	
16-910	 LED Light Body Assembly <i>Battery and charger not included.</i>	
16-913	 Rear Cowling	
16-915	 Cowling Seal	
16-916	 Protective Lens	
16-917	 Latch	
16-918	 Jaw Mount - for T-Link <i>Includes screw.</i>	
16-919	 QR Latch Lever	
16-923	 Hinge Pin	
16-926	 Latch Lever Assembly <i>Includes 16-919.</i>	

Vision-Link™ Light (#16-910)

The Vision-Link light securely mounts to the chin of the Z-Link, illuminating your immediate workspace.



Z-Link® Respirator

Multi-purpose Respiratory Protection



Z-Link Parts

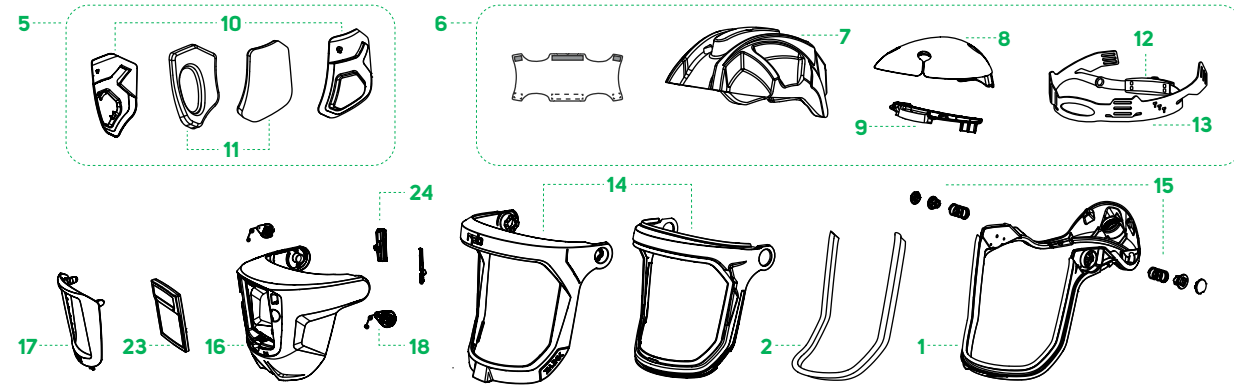

GVS Part # / Description	GVS Part # / Description
1 16-514 Jaw Assembly - Includes screws and 16-515.	14 16-611 Visor
2 16-515 Lens Seal - For jaw assembly.	15 16-616 Pivot Assembly
- 16-516 Quiet-Link™ Earmuff Bracket - Pair, includes screws.	16 16-671 Z-Link+® Weld Visor - ADF lens not included.
- 16-518 Rear Cape Clip	17 16-672 Welding Lens Retainer
- 16-519 Air Inlet Adapter	18 16-673 Z-Link+® Weld Visor Attachment Clips and Springs
5 16-520-S Comfort-Fit Side Padding System	- 16-711 Zytec® FR Face Seal
6 16-520-T Fit System	- 16-712 Tychem® 2000 Face Seal
7 16-521 Impact Absorber	- 16-721 Zytec® FR Shoulder Cape
8 16-522 Comfort Pad	- 16-723 Tychem® 4000 Shoulder Cape
- 16-523 Air Director	- 16-724 Aluminized Shoulder Cape
9 16-525 Head Harness Bracket and Air Director	- 16-731 Zytec® FR Chin Seal
10 16-527 Comfort-Fit Side Padding Frames	23 16-871 RPB® ADF - ANSI Z87w, 1/1/2, CSA Z94.3-15.
11 16-528 Comfort-Fit Foam Pads - Pair.	24 16-875 Magnifying Lens Holder Assembly
12 16-530 Head Harness Ratchet Assembly	- 16-876 Clip for Weld Lens
13 16-531 Head Harness Assembly - Includes 16-530.	

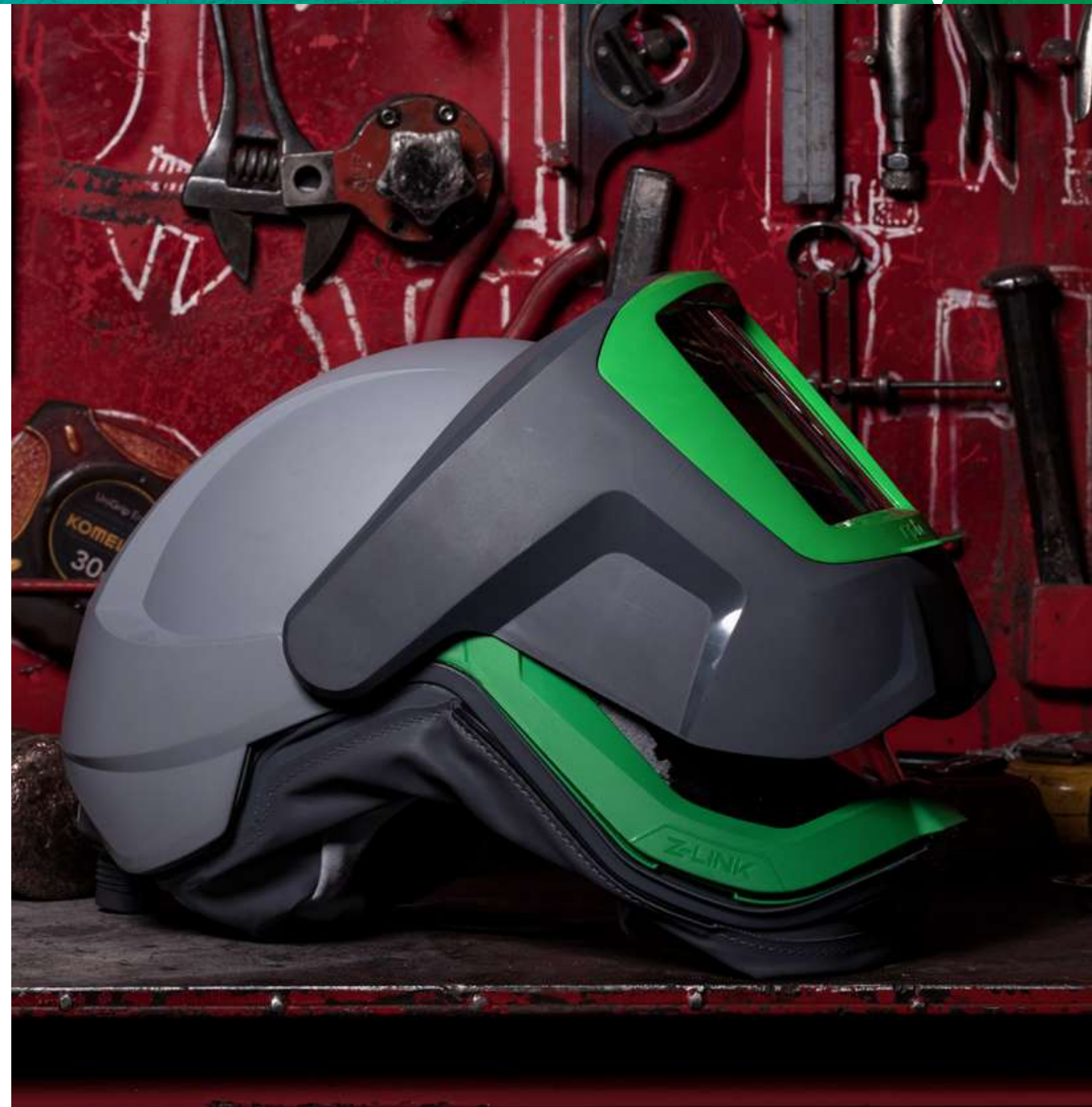

Z4[®] Respirator

Powerful Protection



With comfort and durability the top priority, GVS-RPB[®] has created the most ergonomically balanced welding respirator available. Its lightweight design and multi-adjustment head suspension system ensures a stable fit that moves with you, reducing aches and strains on your neck, allowing you to enjoy life's best moments.

The Z4[®] boasts an optically clear grinding visor and a flip-up welding visor designed to increase operator productivity. Visibility is further enhanced by clip-in shade 5 side windows offering maximum peripheral vision. These can also be switched out for window blockers which are included in the standard package.

The Z4 includes the large GVS-RPB ADF lens with 1/1/1/2 optical quality rating guaranteeing uniform shading and distortion free vision, allowing you to work safely and more comfortably for longer across different angles.

To further increase your comfort and stability, the Z4 can also be fitted with the Comfort-Link[™] padding system for an individualized fit.

The Z4 is certified to the standards below:

NIOSH
APPROVED
PAPR & SAR TYPE C

ANSI
S3.19
HEARING PROTECTION
Only in conjunction with 18-S24 earmuffs.
Z87+
EYE & FACE PROTECTION
Z87W
WELDING EYE PROTECTION

SEI
Certified Model
Modèle certifié
CSA Z94.3-15
EYE & FACE PROTECTION
Class 7D and 7B Respirator Facepiece
PROTECTION DES YEUX ET DU VISAGE
Masque respiratoire classe 7D et 7B

Flip up welding visor during grinding, while maintaining respiratory protection.

Optimum vision with a clear replaceable ANSI Z87+ certified grinding lens.

Lightweight headtop weighing just 805g with ADF and cape.

Aerodynamic shell design deflects fumes away.

Large auto darkening welding lens with a 1/1/1/2 rating. Variable lens shade (9-13).

Replaceable impact and ADF lenses for ease of maintenance. Optional magnifying lens available.

Comfortable multi-adjustment head suspension system - ergonomically balanced to reduce fatigue.

The dual air distribution system delivers 75% of air supply to your breathe zone via a multi-directional outlet. The remaining 25% is directed over the grinding visor to prevent fogging.



FR rated head cover and cape.

Dual Air Distribution System

Air is delivered through the dual air distribution system, flowing over the grinding visor to eliminate lens fogging and also to the breathe zone. With the adjuster you can control the direction of the incoming air to suit your preferences.









Z4 Headtop

GVS Part #	Description	Certifications
15-010-11	 Z4 Respirator - FR Face Seal <i>Package also includes:</i> <ul style="list-style-type: none"> 1/1/1/2 ADF lens Slim-Line ear defenders. 	NIOSH PAPR & SAR Type C, ANSI S3.19*, ANSI Z87+, ANSI Z87W, c SEI CSA Z94.3-15
15-010-21	 Z4 Respirator - FR Shoulder Cape <i>Package also includes:</i> <ul style="list-style-type: none"> 1/1/1/2 ADF lens Slim-Line ear defenders. 	NIOSH PAPR & SAR Type C, ANSI S3.19*, ANSI Z87+, ANSI Z87W, c SEI CSA Z94.3-15
15-110-21	 Z4 Respirator with FR Shoulder Cape <i>Package also includes:</i> <ul style="list-style-type: none"> 1/1/1/2 ADF lens Slim-Line ear defenders Bump cap. 	NIOSH PAPR & SAR Type C, ANSI S3.19*, ANSI Z87+, ANSI Z87W, c SEI CSA Z94.3-15

Z4 SAR Packages *Please visit gvs-rpb.com for more information about other package options available.*











GVS Part #	Description	Certifications
15-015-11	 Z4 Respirator with FR Face Seal and C40[™] Climate Control Device <i>Package also includes:</i> <ul style="list-style-type: none"> 1/1/1/2 ADF lens SAR breathing tube Slim-Line ear defenders. 	NIOSH SAR Type C, ANSI S3.19*, ANSI Z87+, ANSI Z87W, c SEI CSA Z94.3-15
15-015-21	 Z4 Respirator with FR Shoulder Cape and C40[™] Climate Control Device <i>Package also includes:</i> <ul style="list-style-type: none"> 1/1/1/2 ADF lens SAR breathing tube Slim-Line ear defenders. 	NIOSH SAR Type C, ANSI S3.19*, ANSI Z87+, ANSI Z87W, c SEI CSA Z94.3-15

Z4 PAPR Packages *Please visit gvs-rpb.com for more information about other package options available.*











GVS Part #	Description	Certifications
15-0015	 Z4 Respirator with FR Face Seal and HX5[™] PAPR <i>Package also includes:</i> <ul style="list-style-type: none"> 1/1/1/2 ADF lens PAPR breathing tube Slim-Line ear defenders. 	NIOSH PAPR Type C, ANSI S3.19*, ANSI Z87+, ANSI Z87W, c SEI CSA Z94.3-15
15-0019	 Z4 Respirator with FR Face Seal and HX5[™] PAPR with Backpack Assembly <i>Package also includes:</i> <ul style="list-style-type: none"> 1/1/1/2 ADF lens PAPR breathing tube Slim-Line ear defenders. 	NIOSH PAPR Type C, ANSI S3.19*, ANSI Z87+, ANSI Z87W, c SEI CSA Z94.3-15
15-018-11-FR	 Z4 Respirator with FR Face Seal and PX5[™] PAPR <i>Package also includes:</i> <ul style="list-style-type: none"> 1/1/1/2 ADF lens PAPR breathing tube Slim-Line ear defenders. 	NIOSH PAPR Type C, ANSI S3.19*, ANSI Z87+, ANSI Z87W, c SEI CSA Z94.3-15
15-018-21-FR	 Z4 Respirator with FR Shoulder Cape and PX5[™] PAPR <i>Package also includes:</i> <ul style="list-style-type: none"> 1/1/1/2 ADF lens PAPR breathing tube Slim-Line ear defenders. 	NIOSH PAPR Type C, ANSI S3.19*, ANSI Z87+, ANSI Z87W, c SEI CSA Z94.3-15
15-118-21-FR	 Z4 Respirator with FR Shoulder Cape, Bump Cap, and PX5[™] PAPR <i>Package also includes:</i> <ul style="list-style-type: none"> 1/1/1/2 ADF lens PAPR breathing tube Slim-Line ear defenders. 	NIOSH PAPR Type C, ANSI S3.19*, ANSI Z87+, ANSI Z87W, c SEI CSA Z94.3-15
15-0014	 Z4 Respirator with FR Shoulder Cape and PX5[™] PAPR with Multi-gas Filter <i>Package also includes:</i> <ul style="list-style-type: none"> 1/1/1/2 ADF lens PAPR breathing tube Slim-Line ear defenders. 	NIOSH PAPR Type C, ANSI S3.19*, ANSI Z87+, ANSI Z87W, c SEI CSA Z94.3-15

**Only in conjunction with #18-524 earmuffs.
See page 6 for more about PAPRs and page 63-67 for more about SARs.*

Z4 Accessories

GVS Part #	Description	Certifications
04-854	 FR Breathing Tube Cover <i>Breathing tube not included.</i>	
04-874	 Short FR Breathing Tube Cover <i>For backpack assembly, breathing tube not included.</i>	
15-821-5	 Side Window Blockers - Shade 5 - Pair.	
15-848	 Comfort-Fit Side Padding System <i>Includes Velcro[®] pieces.</i>	
15-850	 Bump Cap <i>Includes Comfort and Brow Pad and Front Strap.</i>	
15-855	 Bump Cap <i>Includes Comfort Pad.</i>	
16-901	 Vision-Link™ Helmet Light Kit* <i>Includes 09-510-RAW, 16-918 and 15-839.</i>	
16-922	 Comms-Link™ In-Helmet Communication System* (Non IS) - Includes 16-529 and 09-913. Radio adaptor sold separately - contact GVS-RPB for more information.	
18-524	 Slim-Line Ear Defenders	ANSI S3.19
18-600	 RPB® Carry Bag	

Z4 Consumables

GVS Part #	Description	Certifications
04-831	 PAPR Breathing Tube	
04-833	 SAR Breathing Tube	
04-841	 Short Breathing Tube <i>- for Backpack Assembly.</i>	
13-072-(1, 1.5, 2 or 2.5)	 Ultra Magnifying Lens <i>Available in 1.0, 1.5, 2.0 and 2.5.</i>	
15-878	 Safety Lens (pk 10)	ANSI Z87+
16-526	 Head Band Brow Pad	
16-872	 Welding ADF/Fixed Shade Impact Lens (pk 10)	
16-873	 Welding ADF Rear Lens (pk 10)	
16-874	 Protective Lens for ADF Impact Lens - Aluminium Coated (pk 10)	
16-878	 Welding Fixed Shade Rear Lens (pk 10)	



Z4® Respirator

Powerful Protection

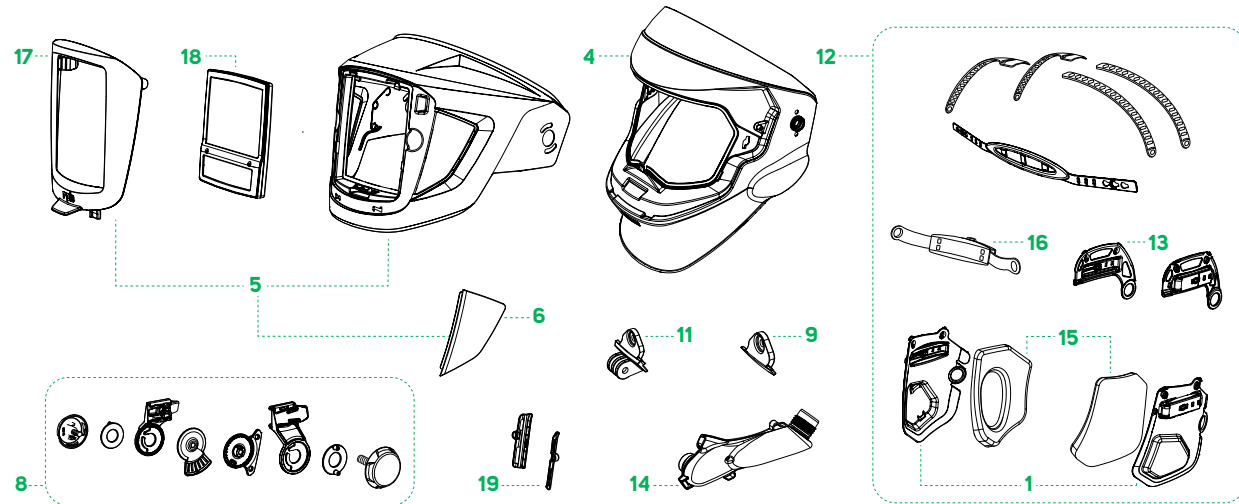

Z4 Parts



GVS Part # / Description		GVS Part # / Description	
1	 15-148 Side Pad Mounts <i>Pair, includes Velcro™ pieces.</i>	11	 15-839 Vision-Link™ Jaw Mount <i>Screw not included.</i>
-	 15-711 FR Face Seal	12	 15-840 Head Harness Assembly <i>Includes 16-530 and 15-848.</i>
-	 15-721 FR Shoulder Cape	13	 15-842 Harness Mount - <i>Pair.</i>
4	 15-811 Face Shield	14	 15-851-1 Air Intake Assembly <i>Includes screws.</i>
5	 15-812 Weld Visor Assembly <i>Includes 16-672 and 15-821.</i>	15	 16-528 Foam Side Pads - <i>Pair.</i>
6	 15-821 Side Window Blockers - <i>Pair, solid gray.</i>	16	 16-530 Head Harness Ratchet Assembly
-	 15-822 Spring Assembly Kit	17	 16-672 Welding Lens Retainer
8	 15-830 Head Harness Bracket and Adjustment System	18	 16-871 RPB® Auto Darkening Filter (ADF) - 1/1/2.
9	 15-831 Front Cape Clip Cover	19	 16-875 Magnifying Lens Holder Assembly
-	 15-832 Safety Lens Bayonet - <i>Pair.</i>		



T-Link® Respirator

Move Freely



The T-Link® has been designed to move with you, not against you. With your comfort and job our main focus, the T-Link transforms how you work, advancing your safety and increasing productivity.

Your ability to see has been at the forefront of our design process, with the T-Link boasting a large visor that enables you to easily connect with your surroundings. This is further supported by the Tychem® hood that securely attaches to the headtop, ensuring your downward and peripheral vision is never compromised. The soft breathable inner-bib and extra tuck-in collar ensures maximized comfort and helps to direct air down your body for cooling.

Fitted with a padded headliner and head suspension system, the headtop's weight is evenly distributed to enhance your experience of comfort, relieving you of aches and strains on your neck. Being fully adjustable ensures the respirator fits securely to all head sizes, maximizing stability and always moving with your head. Our innovative design ensures you have a greater range of movement, so you can focus on the task at hand.

The T-Link is certified to the standards below:

NIOSH
APPROVED
PAPR & SAR TYPE C

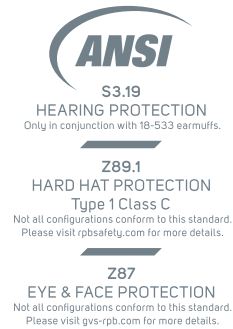

Option of bump cap or ANSI Z89.1 certified hard hat protection.

Padded headliner supports weight distribution while relieving you of the effects of any pressure points.

Air flow and distribution is fully adjustable with the air deflector system to suit personal preference.

Optional ANSI Z87 certified safety lens.

Large viewing window for exceptional downward and peripheral vision.

Fixed lens frame ensures the lens will never hit your nose or optical aids being used.

Optically clear peel-off and cassette lenses available.

Two cape materials available: DuPont™ Tychem® 2000, DuPont™ Tychem® 4000.

Breathing tube easily attaches to the respirator and swivels to eliminate tangles. Centralized location ensures even weight distribution.

Adjustable ratchet system ensures a customized fit that supports movement, while increasing comfort and productivity.

Soft, breathable inner-bib and long tuck-in collar for extra protection and upper body air flow.





Optional Comfort-Link™ Fit System





The Comfort-Link™ is an optional, fully-adjustable fit system that allows total control of helmet and head placement as well as making sure the T-Link moves with your head.



T-Link Headtops



GVS Part #	Description	Certifications
17-110-12	 <p>T-Link Respirator - Tychem® 2000 Hood Package also includes: ■ Bump cap assembly.</p>	NIOSH PAPR & SAR Type C, ANSI S3.19*, ANSI Z87†
17-010-12	 <p>T-Link Respirator - Tychem® 2000 Hood Package also includes: ■ Hard hat assembly.</p>	NIOSH PAPR & SAR Type C, ANSI S3.19*, ANSI Z89.1†, ANSI Z87†
17-010-13	 <p>T-Link Respirator - Tychem® 4000 Hood with Sealed Seams Package also includes: ■ Hard hat assembly.</p>	NIOSH PAPR & SAR Type C, ANSI S3.19*, ANSI Z89.1†, ANSI Z87†

T-Link SAR Packages Please visit gvs-rpb.com for more information about other package options available.









GVS Part #	Description	Certifications
17-015-12	 <p>T-Link Respirator with Tychem® 2000 Hood and C40™ Climate Control Device Package also includes: ■ Hard hat assembly ■ SAR breathing tube.</p>	NIOSH SAR Type C, ANSI S3.19*, ANSI Z89.1†, ANSI Z87†
17-015-13	 <p>T-Link Respirator with Tychem® 4000 Hood with Sealed Seams and C40™ Climate Control Device Package also includes: ■ Hard hat assembly ■ SAR breathing tube.</p>	NIOSH SAR Type C, ANSI S3.19*, ANSI Z87†
17-111-12	 <p>T-Link Respirator with Tychem® 2000 Hood and Constant Flow Valve Package also includes: ■ Bump cap assembly ■ SAR breathing tube.</p>	NIOSH SAR Type C, ANSI S3.19*, ANSI Z87†
17-115-12	 <p>T-Link Respirator with Tychem® 2000 Hood and C40™ Climate Control Device Package also includes: ■ Bump cap assembly ■ SAR breathing tube.</p>	NIOSH SAR Type C, ANSI S3.19*, ANSI Z87†

*Only in conjunction with #18-533 earmuffs.
 †Not all configurations conform to this standard.
 Please visit gvs-rpb.com for more details.

T-Link PAPR Packages Please visit gvs-rpb.com for more information about other package options available.









GVS Part #	Description	Certifications
17-118-12	 <p>T-Link Respirator with Tychem® 2000 Hood and PX5® PAPR Package also includes: ■ Bump cap assembly ■ PAPR breathing tube.</p>	NIOSH PAPR Type C, ANSI S3.19*, ANSI Z87†
17-118-13	 <p>T-Link Respirator with Tychem® 4000 Hood with Sealed Seams and PX5® PAPR Package also includes: ■ Bump cap assembly ■ PAPR breathing tube.</p>	NIOSH PAPR Type C, ANSI S3.19*, ANSI Z87†

T-Link Accessories

GVS Part #	Description	Certifications
04-852	 <p>Tychem® Breathing Tube Cover Breathing tube not included.</p>	
04-856	 <p>Disposable/Decon Breathing Tube Sleeve (pk 10) Breathing tube not included.</p>	
04-872	 <p>Short Tychem® Breathing Tube Cover For backpack assembly, breathing tube not included.</p>	
16-520-S	 <p>Comfort-Fit Side Padding System</p>	
16-901	 <p>Vision-Link™ Helmet Light Kit* Includes 09-510-RAW, 16-918 and 15-839.</p>	
16-922	 <p>Comms-Link™ In-Helmet Communication System* (Non IS) - Includes 16-529 and 09-913. Radio adaptor sold separately - contact GVS-RPB for more information.</p>	
18-533	 <p>Quiet-Link™ Helmet Mounted Earmuffs Includes 18-535 suspension bracket.</p>	ANSI S3.19
18-535	 <p>Quiet-Link™ Suspension Bracket</p>	
18-600	 <p>RPB® Carry Bag</p>	









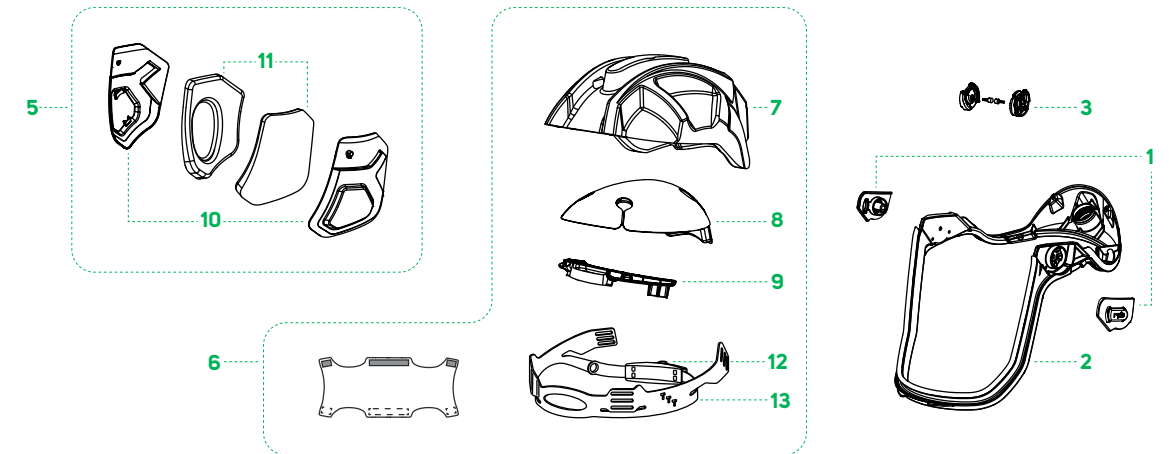





*Vision-Link™ and Comms-Link™ parts can be found on page 24-25.

T-Link Consumables

GVS Part #	Description	Certifications
04-831	 PAPR Breathing Tube	
04-833	 SAR Breathing Tube	
04-841	 Short Breathing Tube <i>For Backpack Assembly.</i>	
16-526	 Head Band Brow Pad	
17-712	 Tychem® 2000 Hood <i>Replacement hood.</i>	
17-713	 Tychem® 4000 Hood with Sealed Seams <i>Replacement hood.</i>	
17-713-SX	 Tychem® 4000 Extra Length Hood with Sealed Seams, Safety Lens and Waist Straps <i>Replacement hood.</i>	
17-815	 Peel-off Lens (pk 25)	
17-817	 Clear Vision Cassette Lens (pk 10) <i>7 layers.</i>	

T-Link Parts



GVS Part # / Description	GVS Part # / Description
 1 16-512 Lens Mount Clips - Pair.	 8 16-522 Comfort Pad
 2 16-514 Jaw Assembly <i>Includes screws and 16-515.</i>	 9 16-525 Head Harness Bracket and Air Director
 3 16-516 Quiet-Link™ Earmuff Bracket <i>Pair, includes screws.</i>	 10 16-527 Comfort-Fit Side Padding Frames
 4 16-519 Air Inlet Adapter	 11 16-528 Comfort Fit Foam Pads - Pair.
 5 16-520-S Comfort-Fit Side Padding System	 12 16-530 Head Harness Ratchet Assembly
 6 16-520-T Fit System	 13 16-531 Head Harness Assembly <i>Includes 16-530.</i>
 7 16-521 Impact Absorber	 - 17-010 Hard Hat Assembly
	 - 17-110 Bump Cap Assembly

T200™ Respirator

Protection That Supports You



The T200™ enables you to work in your environment free of respiratory hazards and discomfort through its supportive design. With positive pressure breathing and true freedom of movement, the T200 ensures you can navigate your surroundings without any restrictions so you can focus on what's in front of you.

Made for customization, the T200's head harness features multiple adjustment points, allowing you to change the fitting to suit the contours and shape of your head. Through the secure fit and streamlined framework, this maximizes stability, relieving you of aches and strains on your neck.

With the large clear visor, experience an uncompromised field of view that allows for greater precision and attention. The T200 also features adjustable lens and air ducting positioning to accommodate for different facial features and the use of optical aids such as loupes and prescription lens glasses.

Get more out of your role by using respiratory protection that supports, not restricts you. Experience more with GVS-RPB®.

The T200 is certified to the standards below:

NIOSH
APPROVED
PAPR & SAR TYPE C

ANSI
S3.19
HEARING PROTECTION
Only in conjunction with 18-524 earmuffs.
Z87
EYE & FACE PROTECTION
Not all configurations conform to this standard.
Please visit gvs-rpb.com for more details.



Customizable Layout

Customize the internal layout with four adjustable head harness points and the moveable lens and air duct system to suit your needs.

Moveable lens and air duct positioning to accommodate for different facial features and optical aids. ■

Deconable head suspension system and disposable hood. ■

Large viewing window for exceptional downward and peripheral vision allowing for both verbal and non-verbal communication. ■

Soft inner neck seal for extra comfort. ■

DuPont™ Tychem® 2000 available in face seal, medium length and full length hood options. Full length hood also available in DuPont™ Tychem® 4000. ■



■ Customizable head suspension system includes an adjustable ratchet at the back and over-the-head straps to allow for a secure, individualized fit.

■ Breathing tube easily attaches to respirator and swivels to eliminate tangles. Centralized location ensures even weight distribution.





T200 Headtops

GVS Part #	Description	Certifications
17-200-22	 <p>T200 Respirator - Tychem® 2000 Face Seal <i>Package also includes:</i> ■ Head harness assembly.</p>	NIOSH PAPR & SAR Type C, ANSI S3.19 [†] , ANSI Z87 [†]
17-210-22	 <p>T200 Respirator - Tychem® 2000 Face Seal <i>Package also includes:</i> ■ Bump Cap assembly.</p>	NIOSH PAPR & SAR Type C, ANSI S3.19 [†] , ANSI Z87 [†]
17-200-32	 <p>T200 Respirator - Tychem® 2000 Shoulder Length Hood with Face Seal <i>Package also includes:</i> ■ Head harness assembly.</p>	NIOSH PAPR & SAR Type C, ANSI S3.19 [†] , ANSI Z87 [†]
17-210-32	 <p>T200 Respirator - Tychem® 2000 Shoulder Length Hood with Face Seal <i>Package also includes:</i> ■ Bump Cap assembly.</p>	NIOSH PAPR & SAR Type C, ANSI S3.19 [†] , ANSI Z87 [†]
17-200-12	 <p>T200 Respirator - Tychem® 2000 Hood <i>Package also includes:</i> ■ Head harness assembly.</p>	NIOSH PAPR & SAR Type C, ANSI S3.19 [†] , ANSI Z87 [†]
17-210-12	 <p>T200 Respirator - Tychem® 2000 Hood <i>Package also includes:</i> ■ Bump Cap assembly.</p>	NIOSH PAPR & SAR Type C, ANSI S3.19 [†] , ANSI Z87 [†]

T200 SAR Packages *Please visit gvs-rpb.com for more information about other package options available.*

GVS Part #	Description	Certifications
17-201-12	 <p>T200 Respirator with Tychem® 2000 Hood and Constant Flow Valve <i>Package also includes:</i> ■ Head harness assembly ■ SAR breathing tube.</p>	NIOSH SAR Type C, ANSI S3.19 [†] , ANSI Z87 [†]
17-205-32	 <p>T200 Respirator with Tychem® 2000 Shoulder Length Hood with Face Seal and C40° Climate Control Device <i>Package also includes:</i> ■ Head harness assembly ■ SAR breathing tube.</p>	NIOSH SAR Type C, ANSI S3.19 [†] , ANSI Z87 [†]

T200 PAPR Packages *Please visit gvs-rpb.com for more information about other package options available.*

GVS Part #	Description	Certifications
17-0015	 <p>T200 Respirator with Tychem® 2000 Hood and PX5® PAPR with OV/AG/HE Cartridge <i>Package also includes:</i> ■ Head harness assembly ■ PAPR breathing tube.</p>	NIOSH PAPR Type C, ANSI S3.19 [†] , ANSI Z87 [†]
17-0016	 <p>T200 Respirator with Tychem® 2000 Face Seal and PX5® PAPR with OV/AG/HE Cartridge <i>Package also includes:</i> ■ Head harness assembly ■ PAPR breathing tube.</p>	NIOSH PAPR Type C, ANSI S3.19 [†] , ANSI Z87 [†]
17-208-22	 <p>T200 Respirator with Tychem® 2000 Face Seal and PX5® PAPR <i>Package also includes:</i> ■ Head harness assembly ■ PAPR breathing tube.</p>	NIOSH PAPR Type C, ANSI S3.19 [†] , ANSI Z87 [†]
17-208-32	 <p>T200 Respirator with Tychem® 2000 Shoulder Length Hood with Face Seal and PX5® PAPR <i>Package also includes:</i> ■ Head harness assembly ■ PAPR breathing tube.</p>	NIOSH PAPR Type C, ANSI S3.19 [†] , ANSI Z87 [†]

T200 Accessories

GVS Part #	Description	Certifications
04-852	Tychem® Breathing Tube Cover <i>Breathing tube not included.</i>	
04-856	Disposable/Decon Breathing Tube Sleeve (pk 10) <i>Breathing tube not included.</i>	
04-872	Short Tychem® Breathing Tube Cover <i>For backpack assembly, breathing tube not included.</i>	
15-850	Bump Cap <i>Includes Comfort and Brow Pad and Front Strap.</i>	
15-855	Bump Cap <i>Includes Comfort Pad.</i>	
18-524	Slim-Line Ear Defenders	ANSI S3.19
18-600	RPB® Carry Bag	

T200 Consumables

GVS Part #	Description	Certifications
04-831	PAPR Breathing Tube	
04-833	SAR Breathing Tube	
04-841	Short Breathing Tube <i>For Backpack Assembly.</i>	
16-526	Head Band Brow Pad	
17-712	Tychem® 2000 Hood with Neck Seal <i>Replacement hood.</i>	
17-713	Tychem® 4000 Hood with Sealed Seams <i>Replacement hood.</i>	
17-722	Tychem® 2000 Face Seal <i>Replacement hood.</i>	
17-732	Tychem® 2000 Hood with Face Seal <i>Replacement hood.</i>	
17-811	Clear Vision Cassette Lens (pk 10) <i>7 layers, for face seal hoods.</i>	
17-815	Tear-off Lens (pk 25) <i>For full length hoods.</i>	
17-817	Clear Vision Cassette Lens (pk 10) <i>7 layers, for full length hoods.</i>	

T200 Parts

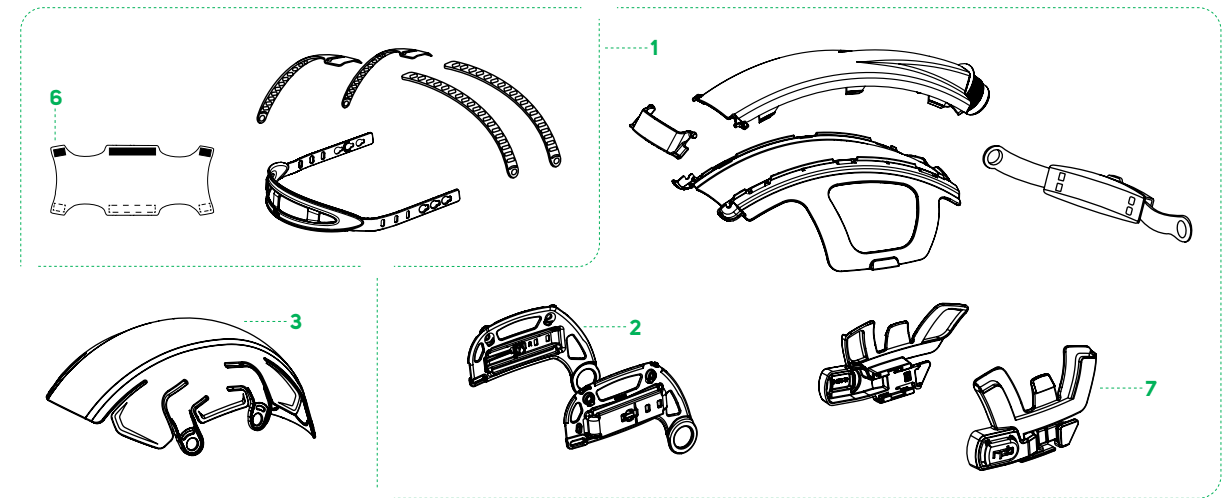

	GVS Part # / Description	GVS Part # / Description	
1	15-841 Head Harness Assembly	4	15-870 Head Harness Assembly with Air Duct and Lens Mount Clips
2	15-842 Harness Mount - <i>Pair.</i>	5	16-530 Head Harness Ratchet Assembly
3	15-850 Bump Cap - <i>Includes Comfort and Brow Pad and Front Strap.</i>	6	16-526 Head Band Brow Pad
-	15-855 Bump Cap <i>Includes Comfort Pad.</i>	7	17-513 Lens Mounts - <i>Pair.</i>

Nova 3[®] Respirator

Unrivaled Comfort



The Nova 3[®] revolutionizes the abrasive blasting experience with the world's most comfortable blasting respirator. With breakthrough technology and comfort, the Nova 3 has been designed around the operator's needs to advance their safety and productivity.

Visibility has been at the forefront of the Nova 3 design process. With the unique cassette lens system, you can experience an optically clear field of view at all times. The superior operating window optimizes peripheral vision and allows for 30% more downward vision than other respirators on the market.

The ratchet padding system provides a customizable fit and molded side pads absorb sound, protecting against hearing loss. Its unique helmet design distributes weight evenly across your head and shoulders, keeping the center of gravity low, eliminating top heaviness, and relieving you from aches and strains on your neck.

All parts are field replaceable to minimize downtime and the padding system is machine washable for hygiene purposes.

The Nova 3 is certified to the standards below:



Bellow seal creates a complete barrier to dust and particulates. ■

Widened perspective provides optimal downward and peripheral field of view. ■

Tear-off lens system to ensure you always have a clear visor when operating. Cassette lens system available to further increase productivity. ■

Streamlined air deflection system distributes air across your breathe zone and across the lens to prevent fogging. ■

Tough helmet shell, manufactured from robust engineering grade nylon offers ANSI Z89.1 certified hard hat protection. ■

Ratchet system and adjustable moulded side pads to help create a secure, customized fit. ■

Large, glove sized latch that is easy to locate and use. ■

Removable visor for efficient lens replacement. ■

Cape is securely attached with eight snap fasteners. ■



Boost Productivity

Our cassette lens system enables you easily tear-off the outer lens when your view becomes obstructed, significantly reducing your downtime.







Nova 3[®] shown with optional L4™ light.

Nova 3[®] Respirator

Unrivalled Comfort



Nova 3 SAR Packages

GVS Part #	Description	Certifications
NV3-702-50	 <p>Nova 3 Blast Respirator - Flow Control Valve <i>Package also includes:</i></p> <ul style="list-style-type: none"> Flow control valve Nylon cape SAR breathing tube. 	NIOSH SAR Type CE, ANSI Z89.1, ANSI Z87+
NV3-703-50	 <p>Nova 3 Blast Respirator - Cold Air Tube <i>Package also includes:</i></p> <ul style="list-style-type: none"> Cold air tube assembly Nylon cape SAR breathing tube. 	NIOSH SAR Type CE, ANSI Z89.1, ANSI Z87+
NV3-704-50	 <p>Nova 3 Blast Respirator - Hot Air Tube <i>Package also includes:</i></p> <ul style="list-style-type: none"> Hot air tube assembly Nylon cape SAR breathing tube. 	NIOSH SAR Type CE, ANSI Z89.1, ANSI Z87+
NV3-705-50	 <p>Nova 3 Blast Respirator - C40 Climate Control Device <i>Package also includes:</i></p> <ul style="list-style-type: none"> C40[™] Climate Control Device Nylon cape SAR breathing tube. 	NIOSH SAR Type CE, ANSI Z89.1, ANSI Z87+













Heavy Duty Blast Suit

Made from heavy duty nylon and available in a range of sizes, the blast suit provides a high level of protection for the front of your body and arms, with a breathable cotton back that helps to keep you cool.

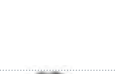

**Only in conjunction with approved respirator.*

Nova 3 Accessories

GVS Part #	Description	Certifications
03-501	 C40 [™] Climate Control Device	NIOSH*
07-701	 RPB [®] Leather Gloves	
07-755-S	 RPB [®] Heavy Duty Blast Suit - Small	
07-755-M	 RPB [®] Heavy Duty Blast Suit - Medium	
07-755-L	 RPB [®] Heavy Duty Blast Suit - Large	
07-755-XL	 RPB [®] Heavy Duty Blast Suit - X Large	
07-755-XXL	 RPB [®] Heavy Duty Blast Suit - XX Large	
07-755-XXXL	 RPB [®] Heavy Duty Blast Suit - XXX Large	
07-755-XXXXL	 RPB [®] Heavy Duty Blast Suit - XXXX Large	
07-761	 RPB [®] Knee Pads - Pair.	
09-502	 L4 [™] Blast Light Assembly* <i>US power connections.</i>	
09-903	 Nova 3 [®] Talk [™] In-Helmet Communication Upgrade Kit* <i>Radio adaptor sold separately.</i>	

Nova 3 Consumables

GVS Part #	Description	Certifications
NV2021B	 SAR Breathing Tube	
NV3-722	 Inner Lens (pk 10)	ANSI Z87+
NV3-722-T	 Inner Lens - Tinted (pk 10)	ANSI Z87+
NV3-724	 Outer Lens (pk 50)	ANSI Z87+
NV3-725	 Tear-off Lens (pk 50)	
NV3-745	 Cassette Lens (pk 20) <i>Each cassette includes 5x tear-offs and 1x outer lens.</i>	
NV3-746	 Mesh Screen (pk 2)	

**L4[™] Light and Nova Talk[™] parts can be found on page 52.*

Nova 3[®] Respirator

Unrivalled Comfort



Nova Talk™ Parts

GVS Part #	Description	Certifications
09-913	Push to Talk Button	
09-916	R-Tex High Noise Headset <i>Includes PTT, radio not supplied.</i>	
09-930	Motorola Connection Cable - Two-pin.	
09-931	Motorola Connection Cable - Multi-pin.	
09-932	Motorola Connection Cable - Multi-pin.	
09-933	Kenwood Connection Cable - Two-pin.	
09-934	Motorola Connection Cable - Multi-pin.	
09-938	Cable for VX-261	
09-939	Cable for Apex Icom IC-F4002	
NV3-733TK	Nova 3 Talk™ Side Padding Covers <i>5 pairs.</i>	

L4™ Light Parts

GVS Part #	Description	Certifications
07-122	Cable and Hose Clamp	
09-021	Power Cable - US.	
09-512	L4™ Light and Mount Kit <i>Includes 09-520.</i>	
09-520	Mounting Clip	
09-522	Outer Lens (pk 10)	
09-525	Battery Charger <i>Power Cable not included.</i>	
09-526	Battery Charger and Power Cable	
09-532-2	Battery Pack	

Nova 3 Parts

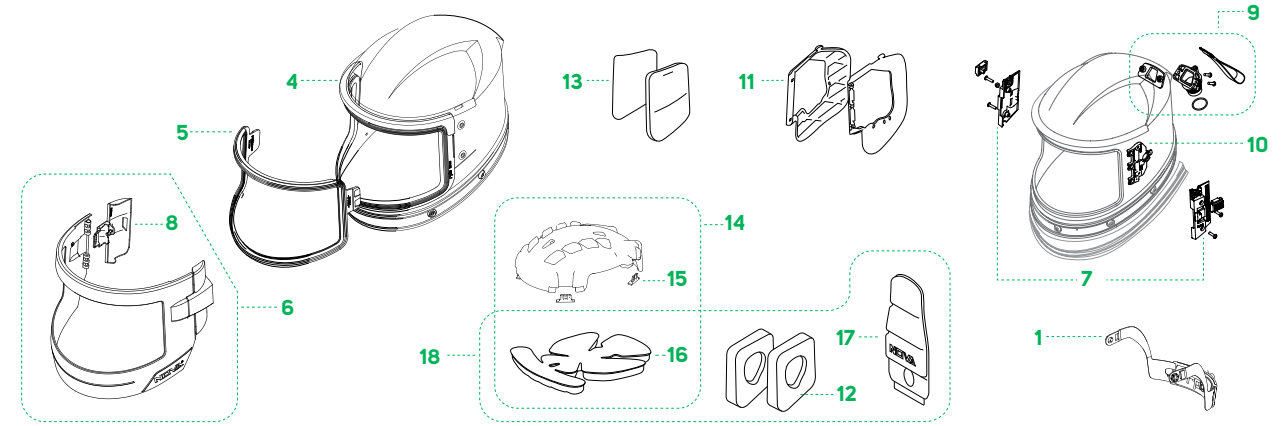

GVS Part # / Description	GVS Part # / Description
1 07-900 Adjustable Head Support	14 NV3-734 Head Liner Kit - <i>Includes NV3-734-1.</i>
- NV2012 Inner Bib	15 NV3-734-1 Head Liner Clips (pk 4)
- NV2041 Domes - 8 sets.	16 NV3-735 Head Liner Foam Padding
4 NV3-721 Inner Gasket	17 NV3-735-1 Neck Pad
5 NV3-723 Inner Lens Frame	18 NV3-736- (A05, A10, A15 or A20) / Hygiene Kit - <i>Available in 5mm, 10mm, 15mm or 20mm.</i>
6 NV3-726 Visor Kit - <i>Includes hinge and latch.</i>	- NV3-750 Nylon Respirator Cape*
7 NV3-727/8 Visor Mount Kit - <i>Includes 4pcs FS-40 nuts and 4pcs FS-46 screws.</i>	- NV3-751 Nylon Respirator Cape - Extra Length*
8 NV3-727-2 Hinge Lock	- NV3-752 Leather Respirator Cape*
9 NV3-729 Air Inlet Kit	- NV3-753-HD Leather Respirator Cape - Extra Length, Heavy Duty*
10 NV3-730 Padding Connectors - <i>Pair.</i>	- NV3-754 Blast Jacket, Size XL*
11 NV3-731 Side Padding Frames - <i>Pair.</i>	- NV3-755 Blast Jacket, Size XXL*
12 NV3-732- (A05, A10, A15 or A20) Side Padding Foam & Covers <i>Available in 5mm, 10mm, 15mm or 20mm.</i>	- NV3-759 Cape Cover Band
13 NV3-733 Side Padding Covers - 5 pairs.	

*Includes NV2012 Inner Bib.





respirators@gvs.com





The Radex® Airline Filter is a large 6-stage filtration system that removes moisture, odor, and particulates from the compressed air-stream.



Radex Airline Filter Packages

GVS Part #	Description	Certifications
04-900	 <p>Radex Airline Filter - 2 Outlet - 1 inch NPT inlet <i>Package also includes:</i></p> <ul style="list-style-type: none"> ■ Filter housing ■ Six stage filter cartridge ■ Base/wall mount ■ Pressure regulator and gauge ■ 2x universal couplers. 	
04-906	 <p>Radex Airline Filter - 6 Outlet - 1 inch NPT inlet <i>Package also includes:</i></p> <ul style="list-style-type: none"> ■ Filter housing ■ Six stage filter cartridge ■ Base/wall mount ■ High flow pressure regulator and gauge ■ 6x universal couplers. 	
04-906-RZ	 <p>Radex Airline Filter - 6 Outlet - 1 inch NPT inlet <i>Package also includes:</i></p> <ul style="list-style-type: none"> ■ Filter housing ■ Six stage filter cartridge ■ Base/wall mount ■ High flow pressure regulator and gauge ■ 6x RZ couplers. 	
04-907	 <p>Radex Airline Filter - Complete Breathing Air System with GX4 Gas Monitor <i>Package also includes:</i></p> <ul style="list-style-type: none"> ■ Filter housing ■ 2x Six stage filter cartridge ■ Base/wall mount ■ High flow pressure regulator and gauge ■ 2x universal couplers ■ GX4® Gas Monitor ■ Mainline pre-filter ■ Micro mist filter 1/2" ■ Brass nipple 1/2" ■ Aluminium wall bracket. 	

Radex Airline Filter Consumables

GVS Part #	Description	Certifications
AFC100	 <p>Replacement Filter Cartridge - generic.</p>	
APF3100	 <p>Radex 6 Stage Filter Cartridge</p>	

Radex Airline Filter Parts

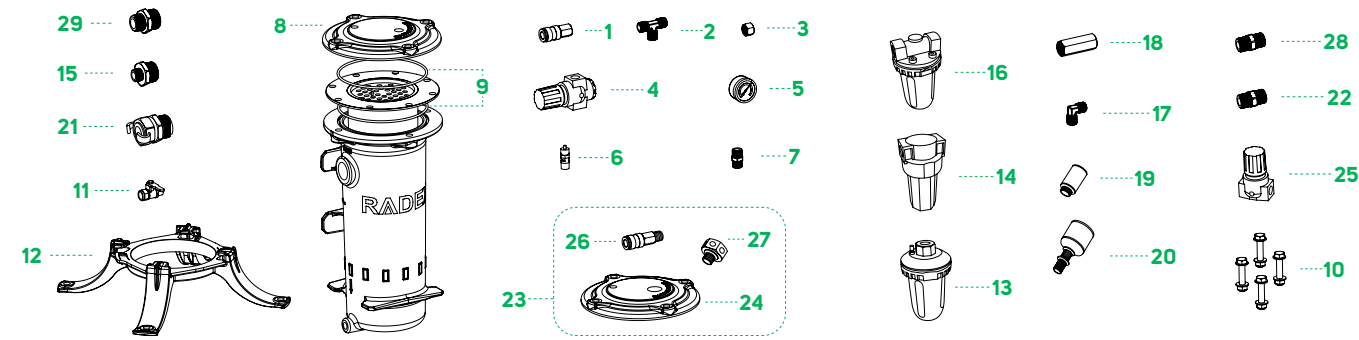

Part # / Description	Part # / Description
1 04-911 1/4" Coupler 3/8" Female Thread	15 04-926 1" x 1/2" Reducing Nipple
2 04-912 3/8" Brass Tee	16 04-927 Mainline Pre-filter
3 04-913 3/8" Brass Cap	17 04-928 Brass Elbow
4 04-914 Pressure Regulator	18 04-929 Filter Element - For 04-927.
5 04-915 Pressure Gauge	19 04-930 Micro Mist Filter Element - For 04-925.
6 04-916 Pressure Relief Valve - 150 psi.	20 04-931 Auto Drain Assembly - For 04-924.
7 04-917 3/8" Brass Nipple	21 04-951 Claw Coupler
8 04-918 Filter Lid - For 04-900.	22 04-952 1/2" x 1/2" Male NPT Nipple
9 04-919 O-Ring - Set of 2.	23 04-960-RZ Six Outlet Upgrade Kit - RZ
10 04-920 Bolt, Nut, Washer - Set of 4.	24 04-961 Six Outlet Filter Lid
11 04-922 Brass Drain Tap	25 04-962 Super High Flow Regulator Includes 04-915.
12 04-923 Base/Wall Mount	26 04-964 1/4" Coupler 3/8" MNPT To fit 04-965 Manifold.
13 04-924 Auto Drain Unit	27 04-965 6 Outlet Manifold
14 04-925 Micro Mist Filter 1/2"	28 04-966 1" NPT Hex Connector



GX4[®] Gas Monitor

Hazardous Gas Detection



The GX4[®] Gas Monitor detects up to four gases simultaneously, alerting the user when there are hazardous gases present near the supplied air source. All data and logs can be accessed in real time.



GX4 Gas Monitor Packages

GVS Part #	Description	Certifications
08-400	 <p>GX4 Gas Monitor - No Sensor <i>Package also includes:</i></p> <ul style="list-style-type: none"> ■ Power adaptor pack ■ Mounting brackets ■ Air supply hose. 	

GX4 Gas Monitor Sensors

GVS Part #	Description	Certifications
08-420-01	 <p>Gas Sensor Cartridge - Carbon Monoxide CO 10ppm</p>	
08-420-02	 <p>Gas Sensor Cartridge - Carbon Monoxide CO 5ppm</p>	
08-420-03	 <p>Gas Sensor Cartridge - Hydrogen Sulphide H₂S 10ppm</p>	
08-420-04	 <p>Gas Sensor Cartridge - Oxygen O₂ 19.5-23%</p>	

GX4 Gas Monitor Accessories

GVS Part #	Description	Certifications
08-231	 <p>Wall Bracket</p>	
08-424	 <p>Heavy Duty Field Case</p>	
08-427	 <p>Heavy Duty Field Case <i>Includes Battery and Charger.</i></p>	
08-434	 <p>Auxiliary Cable 50ft with Bare End</p>	
08-435	 <p>Strobe Light with 50ft Cable</p>	
08-436	 <p>Auxiliary Strobe & Alarm Tower with 50ft Cable</p>	









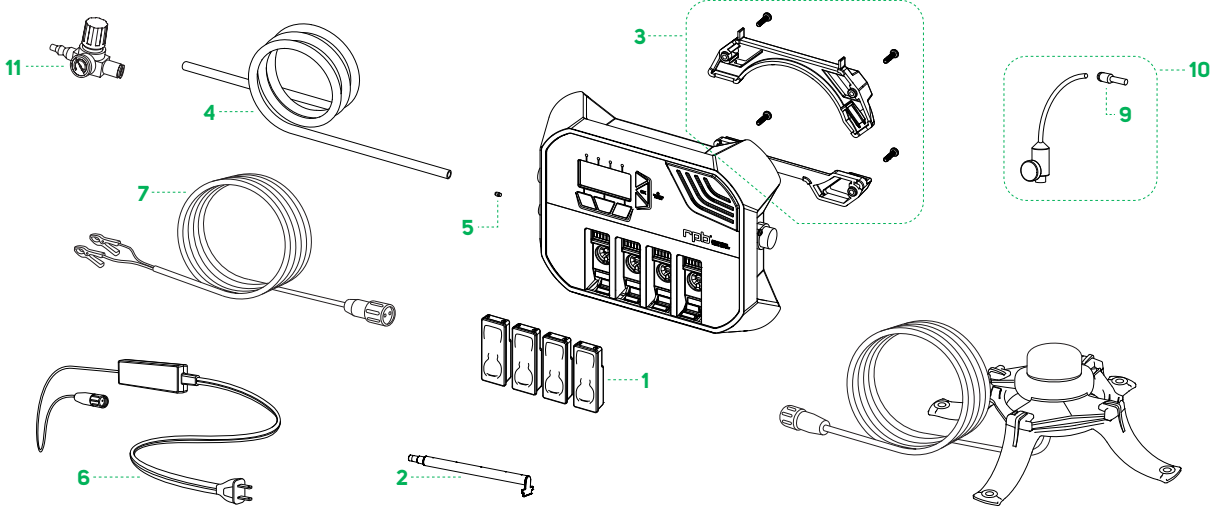









GX4[®] Gas Monitor

Hazardous Gas Detection



GX4 Gas Monitor Parts



Part # / Description	Part # / Description
1  08-420 Blank Sensor Case	10  08-451 Calibration Flow Regulator <i>For CO & Zero Air Gas Bottles, includes 08-450.</i>
2  08-422 Sensor Manifold Tube	10  08-452 Calibration Flow Regulator <i>For H2S Gas Bottles, includes hose and fitting.</i>
3  08-425 Mounting Bracket <i>Pair, includes screws.</i>	-  08-460 Zero Air <i>20.9% Oxygen in Nitrogen.</i>
4  08-428 Air Supply Hose <i>Includes one touch connector.</i>	-  08-461 CO 20ppm <i>20ppm Carbon Monoxide in Air.</i>
4  08-428-RZ Air Supply Hose with RZ Fittings <i>Includes one touch connector.</i>	-  08-462 H2S 20ppm <i>20ppm Hydrogen Sulfide in Nitrogen.</i>
5  08-429 M5 Inlet Filter	11  08-470 External Flow Regulator
6  08-430 Power Pack Assembly - US	11  08-470-RZ External Flow Regulator with RZ Fittings
7  08-431 12 Volt Battery Clip & Plug	-  09-021 Power Cable
8  08-437 AUX, Field Install Jack	
9  08-450 Calibration Adapter	



Supplied Air Flow Control Devices

Control Your Environment



The flow control range allows the operator to control the flow rate and temperature of their supplied breathing air when paired with their required SAR headtop.

These devices fit around the user's waist (belt included) and connect the supplied breathing airline to the appropriate SAR respirator (sold separately).



Supplied Air Flow Devices

GVS Part #	Description	Certifications
03-101	Constant Flow Valve Assembly	NIOSH*
03-106	Constant Flow Valve Assembly - Low Pressure	NIOSH*
03-501	RPB® C40™ Climate Control Device	NIOSH*
03-501-FR	RPB® C40™ Climate Control Device - FR	NIOSH*
03-501-RZ	RPB® C40™ Climate Control Device - RZ	NIOSH*
03-504	RPB® C40™ Climate Control Device - Schrader	NIOSH*
4000-01	Cold Air Tube Assembly	NIOSH*
4000-02	Cold Air Tube Assembly - GHT Thread	NIOSH*
4000-40	Cold Air Tube Assembly - Silenced	NIOSH*
4000-20	Hot Air Tube Assembly	NIOSH*
NV2016	Flow Control Valve Assembly	NIOSH*

Supplied Air Breathing Tubes

GVS Part #	Description	Certifications
03-031	SAR Breathing Tube For Z3™.	
04-833	SAR Breathing Tube For Z-Link®, Z4® and T-Link®.	
NV2021B	SAR Breathing Tube For Nova 3®, Nova 2000® and Astro™.	
04-852	Tychem® Breathing Tube Cover Breathing tube not included.	
04-854	FR Breathing Tube Cover Breathing tube not included.	
04-855	Aluminized Breathing Tube Cover Breathing tube not included.	
04-856	Disposable/Decon Breathing Tube Sleeve (pk 10) Breathing tube not included.	

*Only in conjunction with approved respirator.

Supplied Air Flow Control Devices

Control Your Environment



Supplied Airlines

GVS Part #	Description	Certifications
NV2028	RPB* 25' Breathing Air Supply Hose 3/8" Diameter <i>Quick Release Fittings.</i>	NIOSH
NV2029	RPB* 50' Breathing Airline Hose 3/8" Diameter <i>Quick Release Fittings.</i>	NIOSH
NV2027	RPB* 100' Breathing Airline Hose 3/8" Diameter <i>Quick Release Fittings.</i>	NIOSH
04-352-25-RZ	RPB* 25' Breathing Air Supply Hose 3/8" Diameter <i>RZ Fittings.</i>	NIOSH
04-352-50-RZ	RPB* 50' Breathing Airline Hose 3/8" Diameter <i>RZ Fittings.</i>	NIOSH
04-352-100-RZ	RPB* 100' Breathing Airline Hose 3/8" Diameter <i>RZ Fittings.</i>	NIOSH
04-342-25	RPB* 25' Breathing Air Supply Hose 3/8" Diameter <i>Schrader Fittings.</i>	NIOSH
04-342-50	RPB* 50' Breathing Airline Hose 3/8" Diameter <i>Schrader Fittings.</i>	NIOSH
04-342-100	RPB* 100' Breathing Airline Hose 3/8" Diameter <i>Schrader Fittings.</i>	NIOSH
NV2035	RPB* 50' Breathing Air Supply Hose 1/2" Diameter <i>Quick Release Fittings.</i>	NIOSH
NV2036	RPB* 100' Breathing Airline Hose 1/2" Diameter <i>Quick Release Fittings.</i>	NIOSH
04-412-15	RPB* 15' Recoil Breathing Air Supply Hose 3/8" Diameter - <i>Standard Coupler.</i>	NIOSH
04-412-25	RPB* 25' Recoil Breathing Airline Hose 3/8" Diameter - <i>Standard Coupler.</i>	NIOSH

Supplied Air Flow Device Parts













GVS Part #	Description	Certifications
03-012-PM	Quick Release Tail 1/4" Male Thread	NIOSH
03-013-PM	Adapter 1/4" GVS-RPB Plug to 3/8" NPT Male Thread	NIOSH
03-042-CF	Schrader Coupler to 1/4" NPT Female	NIOSH
03-042-PF	Schrader Plug to 1/4" NPT Female	NIOSH
03-042-PM	DQC SHD-Series Schrader Plug to 1/4" NPT Male	NIOSH
03-043-PM	Schrader Twist Lock 3/8 MNPT Plug	NIOSH
03-052-PM-RZ	Quick Release Tail 1/4" Male Thread with RZ Fitting	NIOSH
4000-03	Top Thread Cap BSP Thread <i>For 4000-01.</i>	
4000-03GHT	Top Thread Cap GHT Thread <i>For 4000-21.</i>	
4000-04	Cold Air Spinner	
4000-05B	Cool Air Tube Body	
4000-05R	Hot Air Tube Body	
4000-07	Breaker	
4000-08	Regulator Body	
4000-09	Spindle and Knob	
4000-10	Locking Screw	
4000-11	Regulator Assembly	
4000-12	Temperature Shield	

Supplied Air Flow Control Devices

Control Your Environment









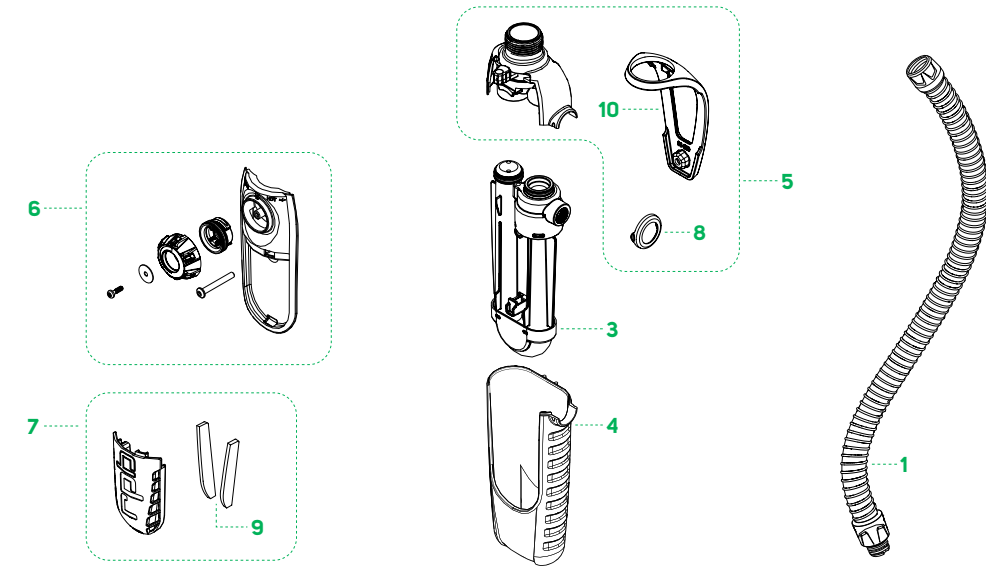































Supplied Air Flow Device Parts

GVS Part #	Description	Certifications
4000-13	 Hot Air Spinner	
4000-14	 Flow Reducer	
4000-15	 Outlet Valve	
4000-16	 Silencer Disc	
4000-16B	 Silencer Disc - Brass	
4000-17	 Retainer Nut	
4000-18	 Outlet Valve Complete Assembly	
4000-38	 Outlet Valve <i>For 4000-40.</i>	
NV2022	 1.5" Nylon Belt	
NV2023	 SAR Breathing Tube Hose Washer (pk 5)	
NV2025	 Quick Release Coupler 1/4" Female Thread	
NV2034	 Adapter 1/2" Low Pressure Plug to 3/8" NPT Male Thread	

C40™ Climate Control Device Parts



Part # / Description	Part # / Description
  04-833 SAR Breathing Tube <i>For Z-Link and T-Link.</i>	  03-510 C40™ U Tube Assembly
  04-852 Tychem® Breathing Tube Cover <i>Breathing tube not included.</i>	  03-514 C40™ Bottom Case
  04-854 FR Breathing Tube Cover <i>Breathing tube not included.</i>	  03-521 C40™ Top Case Assembly
  04-855 Aluminized Breathing Tube Cover <i>Breathing tube not included.</i>	  03-522 C40™ Exhaust Assembly
  04-856 Disposable/Decon Breathing Tube Sleeve (pk 10)	  03-526 C40™ Silencer Assembly
  04-862 C40™ Tychem® Cover	  03-536 C40™ Inlet Collar
  03-012-PMS 1/4" Plug to 1/4" NPT Male Swivel	  03-537 C40™ Silencers - <i>Pair.</i>
  03-042-PMS Schrader Twist Lock MNPT Swivel Plug	  03-539 C40™ Belt Loop - <i>03-521 replacement required for pre-July 2020 C40™.</i>
  03-052-PMS-RZ 1/4" Male Thread RZ Coupler Swivel Plug	  07-765 2" Belt Assembly
	  07-765-FR 2" Belt Assembly - <i>FR</i>















Elipse® Half-face Respirator













With its low-profile, flexible design, the Elipse® molds to the shapes and contours of your face, enhancing the tight-fitting seal while ensuring your comfort and constant protection.











Elipse Respirators and Filters

GVS Part #	Description	Certifications
SPR451 SPR457	 Elipse P100 Available in S/M and M/L Package also includes: ■ Replaceable filters.	NIOSH
SPR321	 P100 Filters Pair, for Elipse SPR451, SPR457, SPR643 and SPR644 respirators, and Integra SPR549 and SPR550 respirators.	NIOSH
SPR449 SPR456	 Elipse P100 Nuisance Odor Available in S/M and M/L Package also includes: ■ Replaceable filters.	NIOSH
SPR450	 P100 Nuisance Odor Filters Pair, for Elipse SPR449 and SPR456 respirators, and Integra SPR551 and SPR552 respirators.	NIOSH
SPR466 SPR467	 Elipse OV/P100 Available in S/M and M/L Package also includes: ■ Replaceable cartridges.	NIOSH
SPR468	 OV/P100 Cartridges Pair, for Elipse SPR466 and SPR467 respirators, and Integra SPR553 and SPR554 respirators.	NIOSH
SPR656 SPR657	 New Elipse OV/P100 Available in S/M and M/L Package also includes: ■ Replaceable cartridges.	NIOSH
SPR658	 New OV/P100 Cartridges Pair, for Elipse SPR656 and SPR657 respirators, and Integra SPR659 and SPR660 respirators.	NIOSH
SPR472 SPR473	 Elipse OV/AG/P100 Available in S/M and M/L Package also includes: ■ Replaceable cartridges.	NIOSH
SPR474	 OV/AG/P100 Cartridges Pair, for Elipse SPR472 and SPR473 respirators, and Integra SPR555 and SPR556 respirators.	NIOSH
SPR481 SPR482	 Elipse Multi-gas Available in S/M and M/L Package also includes: ■ Replaceable cartridges.	NIOSH
SPR483	 Multi-gas Cartridges Pair, for Elipse SPR481 and SPR482 respirators, and Integra SPR630 and SPR631 respirators.	NIOSH
SPR484 SPR485	 Elipse Multi-gas P100 Available in S/M and M/L Package also includes: ■ Replaceable cartridges.	NIOSH
SPR486	 Multi-gas P100 Cartridges Pair, for Elipse SPR484 and SPR485 respirators, and Integra SPR623 and SPR624 respirators.	NIOSH

Elipse Accessories

GVS Part #	Description	Certifications
SPM001	 Hard Carry Case for P100 <i>Fits respirators SPR449, SPR451, SPR456, SPR457, SPR643 and SPR644.</i>	
SPM008	 Hard Carry Case <i>Fits respirators SPR656 and SPR657.</i>	
SPM009	 Hard Carry Case for High Efficiency Gas <i>Fits respirators SPR466, SPR467, SPR472, SPR473, SPR481, SPR482, SPR484 and SPR485.</i>	
SPM414	 Portacount Face Fit Kit Adaptor <i>For P100 Filters</i>	
SPM420	 Pre-filter Kits <i>Includes 2 holders and 10 pads, for SPR656, SPR657, SPR659 and SPR660 filters.</i>	
SPM421	 Pre-filter Pads (pk 20) <i>For SPM420.</i>	
SPM562	 Plastic Cover Kit for Low Profile Cartridges <i>Fits Elipse OV/P100 (SPR656 and SPR657) and Integra OV/P100 (SPR659 and SPR 650), and SPR658 cartridges.</i>	
SPM578	 Respirator Cradle Pad	
SPM587	 Starter Kit <i>Includes SPR457, 1 SPR321 and 1 SPM001.</i>	
SPM646	 Portacount Face Fit Kit Adaptor <i>For gas and vapor cartridges</i>	

Elipse Parts

GVS Part #	Description	Certifications
SPM557 Size S/M SPM558 Size M/L	 Respirator Particulate Strap Support Assembly	
SPM560	 Headband Connectors <i>- for Elipse P100.</i>	
SPM561	 Headband Clips (pk 4) <i>For High Efficiency Gas Respirators.</i>	
SPM563	 Turn-buckles (pk 2)	
SPM564	 Headband Clips (pk 4) <i>For High Efficiency Gas Respirators.</i>	
SPM565	 Slim Stubber Head Band Pad	
SPM566	 Valve Cover	
SPM568	 Valve Diaphragms (pk 3) <i>For Respirators and Gas filters.</i>	
SPM570 Size S/M SPR571 Size M/L	 Elastics for Respirators <i>Pair.</i>	

Elipse® Starter Kit (Part # SPM587)

The Elipse Starter Kit includes an Elipse P100 Respirator (SPR457) which comes with filters already installed, an extra set of P100 filters (SPR321), and a protective carry case (SPR001) all in one convenient package.



Elipse® Half-face Respirator

P100 with Source Control



The Source Control version of the Elipse respirator is an alternative to N95 disposable respirators, reducing waste and costs for hospitals. It does not have an exhalation valve in order to avoid cross-contamination, and the exhalation valves were removed to improve the resistance providing optimal airflow.





The Segre provides a high performing, economic option for those after disposable respiratory protection. With our advanced filter technology and comfort features, the Segre N99 takes care of your safety, so you can focus on the task at hand.



Elipse P100 Source Control Half-face Respirator

GVS Part #	Description	Certifications
SPR643 Size S/M SPR644 Size M/L	 Elipse P100 Source Control Package also includes: ■ Replaceable filters.	NIOSH
SPR321	 P100 Filters Pair, for Elipse SPR451, SPR457, SPR643 and SPR644 respirators, and Integra SPR549 and SPR550 respirators.	NIOSH

Segre Respirator

GVS Part #	Description	Certifications
N31000	 Segre - N99 Respirator - one size.	NIOSH
SPM900	 UV Sterilizer Respirator not included.	















Integra® Half-face Respirator











With its low-profile design, the Integra® ensures a clear line of sight, enhancing precision and accuracy when working, while protecting your eyes with the addition of integrated safety glasses.









Integra Respirators and Filters

GVS Part #	Description	Certifications
SPR549 SPR550	 <p>Integra P100 Available in S/M and M/L Package also includes: ■ Replaceable filters.</p>	NIOSH, ANZI Z87+, CAN/CSA Z94.3-20
SPR321	 <p>P100 Filters Pair, for Elipse SPR451, SPR457, SPR643 and SPR644 respirators, and Integra SPR549 and SPR550 respirators.</p>	NIOSH
SPR551 SPR552	 <p>Integra P100 Nuisance Odor Available in S/M and M/L Package also includes: ■ Replaceable filters.</p>	NIOSH, ANZI Z87+, CAN/CSA Z94.3-20
SPR450	 <p>P100 Nuisance Odor Filters Pair, for Elipse SPR449 and SPR456 respirators, and Integra SPR551 and SPR552 respirators.</p>	NIOSH
SPR553 SPR554	 <p>Integra OV/P100 Available in S/M and M/L Package also includes: ■ Replaceable cartridges.</p>	NIOSH, ANZI Z87+, CAN/CSA Z94.3-20
SPR468	 <p>OV/P100 Cartridges Pair, for Elipse SPR466 and SPR467 respirators, and Integra SPR553 and SPR554 respirators.</p>	NIOSH
SPR659 SPR660	 <p>New Integra OV/P100 Available in S/M and M/L Package also includes: ■ Replaceable cartridges.</p>	NIOSH, ANZI Z87+, CAN/CSA Z94.3-20
SPR658	 <p>New OV/P100 Cartridges Pair, for Elipse SPR466 and SPR467 respirators, and Integra SPR559 and SPR560 respirators.</p>	NIOSH
SPR555 SPR556	 <p>Integra OV/AG/P100 Available in S/M and M/L Package also includes: ■ Replaceable cartridges.</p>	NIOSH, ANZI Z87+, CAN/CSA Z94.3-20
SPR474	 <p>OV/AG/P100 Cartridges Pair, for Elipse SPR472 and SPR473 respirators, and Integra SPR555 and SPR556 respirators.</p>	NIOSH
SPR630 SPR631	 <p>Integra Multi-gas Available in S/M and M/L Package also includes: ■ Replaceable cartridges.</p>	NIOSH, ANZI Z87+, CAN/CSA Z94.3-20
SPR483	 <p>Multi-gas Cartridges Pair, for Elipse SPR481 and SPR482 respirators, and Integra SPR630 and SPR631 respirators.</p>	NIOSH
SPR623 SPR624	 <p>Integra Multi-gas P100 Available in S/M and M/L Package also includes: ■ Replaceable cartridges.</p>	NIOSH, ANZI Z87+, CAN/CSA Z94.3-20
SPR486	 <p>Multi-gas P100 Cartridges Pair, for Elipse SPR484 and SPR485 respirators, and Integra SPR623 and SPR624 respirators.</p>	NIOSH

Integra Accessories

GVS Part #	Description	Certifications
SPM007	 Hard Carry Case <i>Fits respirators SPR549, SPR550, SPR551, SPR552, SPR553, SPR554, SPR555, SPR556, SPR623, SPR624, SPR630, and SPR631.</i>	
SPM414	 Portacount Face Fit Kit Adaptor	
SPM420	 Pre-filter Kits <i>Includes 2 holders and 10 pads, for SPR656, SPR657, SPR659 and SPR660 filters.</i>	
SPM421	 Pre-filter Pads (pk 20) <i>For SPM420.</i>	
SPM520	 Peel-off Visor (pk 10)	
SPM562	 Plastic Cover Kit for Low Profile Cartridges <i>Fits Elipse OV/P100 (SPR656 and SPR657) and Integra OV/P100 (SPR659 and SPR 650), and SPR658 cartridges.</i>	
SPM639	 Prescription Lens Insert	
SPM646	 Portacount Face Fit Kit Adaptor <i>For gas and vapor cartridges.</i>	

Integra Parts

GVS Part #	Description	Certifications
SPM559	 Respirator Particulate Strap Support Assembly	
SPM561	 Headband Clips (pk 4) <i>For High Efficiency Gas Respirators.</i>	
SPM565	 Slim Stubber Head Band Pad	
SPM567	 Headband Connectors (pk 2) <i>For High Efficiency Gas Respirators.</i>	
SPM569	 Headband Connectors (pk 2) <i>For Integra Low Profile Gas Respirators.</i>	
SPM570 Size S/M SPM571 Size M/L	 Elastics for Respirators <i>Pair.</i>	

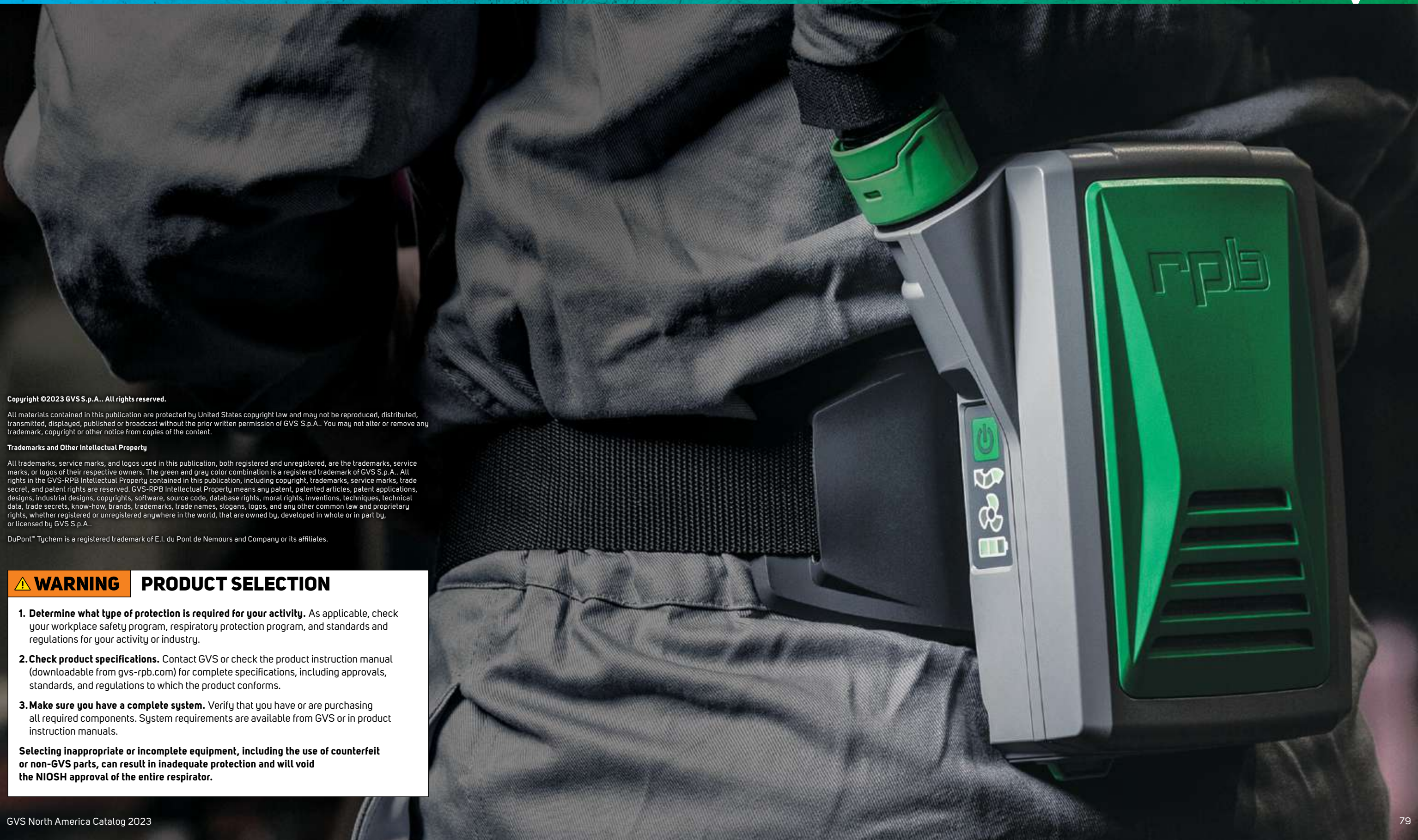

Copyright ©2023 GVS S.p.A.. All rights reserved.

All materials contained in this publication are protected by United States copyright law and may not be reproduced, distributed, transmitted, displayed, published or broadcast without the prior written permission of GVS S.p.A.. You may not alter or remove any trademark, copyright or other notice from copies of the content.

Trademarks and Other Intellectual Property

All trademarks, service marks, and logos used in this publication, both registered and unregistered, are the trademarks, service marks, or logos of their respective owners. The green and gray color combination is a registered trademark of GVS S.p.A.. All rights in the GVS-RPB Intellectual Property contained in this publication, including copyright, trademarks, service marks, trade secret, and patent rights are reserved. GVS-RPB Intellectual Property means any patent, patented articles, patent applications, designs, industrial designs, copyrights, software, source code, database rights, moral rights, inventions, techniques, technical data, trade secrets, know-how, brands, trademarks, trade names, slogans, logos, and any other common law and proprietary rights, whether registered or unregistered anywhere in the world, that are owned by, developed in whole or in part by, or licensed by GVS S.p.A..

DuPont™ Tychem is a registered trademark of E.I. du Pont de Nemours and Company or its affiliates.

⚠ WARNING PRODUCT SELECTION

- 1. Determine what type of protection is required for your activity.** As applicable, check your workplace safety program, respiratory protection program, and standards and regulations for your activity or industry.
- 2. Check product specifications.** Contact GVS or check the product instruction manual (downloadable from gvs-rpb.com) for complete specifications, including approvals, standards, and regulations to which the product conforms.
- 3. Make sure you have a complete system.** Verify that you have or are purchasing all required components. System requirements are available from GVS or in product instruction manuals.

Selecting inappropriate or incomplete equipment, including the use of counterfeit or non-GVS parts, can result in inadequate protection and will void the NIOSH approval of the entire respirator.

Want to know more?

Contact us:

Parts are regularly added and updated, and changes occur from time to time.

Contact our team for the latest information.

EUROPE

Italy - Head Office

GVS S.P.A.
Via Roma 50,
40069 Zola Predosa (BO), Italy
Tel. +39-051-617-6311
gvs@gvs.com

United Kingdom

GVS Filter Technology UK Ltd.
NFC House, Vickers Industrial Estate
Mellishaw Lane, Morecambe
Lancashire LA3 3EN
Tel. +44-(0)-1524-847-600
gvsuk@gvs.com

Romania

GVS Microfiltrazione srl
Sat Ciorani de Sus 1E, 107156
Ciorani Prahova România
Tel. +40-244-463044
gvsromania@gvs.com

Turkey

GVS Türkiye
Cevizli mah. Zuhul cad.
Ritim Istanbul no: 44 A-1 Blok D.371
Maltepe / Istanbul
Tel. +90-216-504-4767
gvsturkey@gvs.com

AMERICAS

U.S.A.

GVS-RPB Safety LLC.
2807 Samoset Rd, Royal Oak,
MI 48073, USA
Tel. 1-866-494-4599
respirators@gvs.com

Mexico

Universal No. 550, Vynmsa
Aeropuerto Apodaca Industrial Park,
Ciudad Apodaca, Nuevo León, C.P.
66626, México
Tel. +52-81-2282-9003
gvmex@gvs.com

Brazil

GVS do Brasil Ltda.
Rodovia Conego Cyriaco
Scaranello Pires 251
Jd. Progresso, CEP 13190-000
Monte Mor (SP), Brasil
Tel. +55-193-879-7200
gvs@gvs.com.br

Argentina

Av. Rivadavia 13.332 Piso 1 Of. 1001
CP: 1704 Ramos Mejía Buenos Aires
Tel. +54-11-49889041
gvsarg@gvs.com

ASIA-PACIFIC

China

GVS Technology (Suzhou) Co., Ltd.
Fengqiao Civil-Run Sci-Tech Park,
602 Changjiang Road, S.N.D.
Suzhou, China 215129
Tel. +86-512-6661-9880
gvschina@gvs.com

Japan

GVS Japan K.K.
KKD Building 4F, 7-10-12
Nishishinjuku Shinjuku-ku,
Tokyo 160-0023
Tel. +81-3-5937-1447
gvsjapan@gvs.com

Korea

GVS Korea Ltd
#315 Bricks Tower
368 Gyungchun-ro (Gaun-dong),
Namyangju-si, Gyunggi-do,
Tel: +82-31-563-9873
gvskorea@gvs.com

India

GVS Filter India Pvt Ltd
Unit No 35 & 36 on First Floor
Ratna Jyot Industrial Premises
Irla Lane, Irla Vile Parlae,
Mumbai 400056, India
gvsindia@gvs.com

Malaysia

GVS Filtration Sdn.Bhd
Lot No 10F-2B, 10th Floor, Tower 5 @
PFCC Jalan Puteri 1/2, Bandar Puteri
47100 Puchong, Selangor, Malaysia
Tel: +60-3-7800-0062
gvsmalaysia@gvs.com

Thailand

GVS Thailand
88 Ratchadaphisek Rd,
Office 10E03 - Khlong Toei,
Bangkok 10110
Tel: +66-2-163-4310
gvsthailand@gvs.com

gvs-rpb.com

 [linkedin.com/showcase/gvs-health-and-safety](https://www.linkedin.com/showcase/gvs-health-and-safety)

 [youtube.com/gvsrpb](https://www.youtube.com/gvsrpb)

respirators@gvs.com